





---







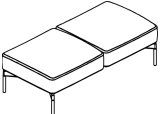
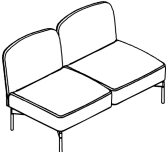
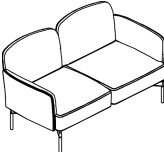
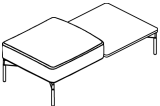
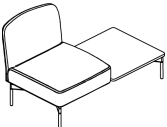
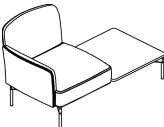

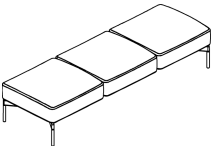
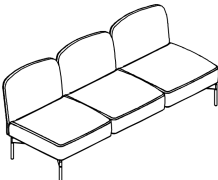
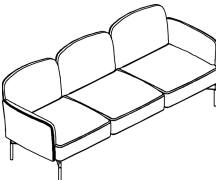
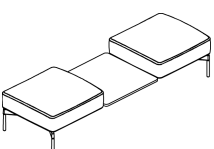
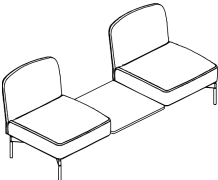
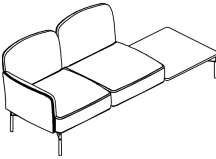
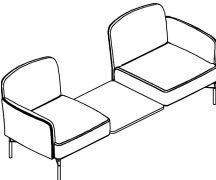
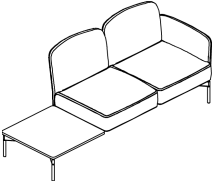
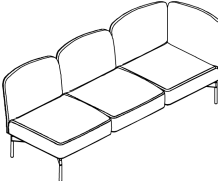
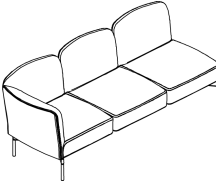
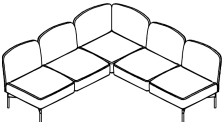
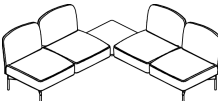

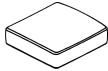

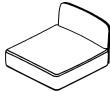
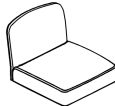

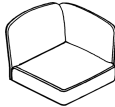
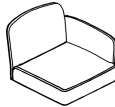

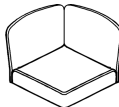
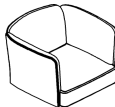
# Pixel™ Lounge

Price List  
July 2023



# Knoll

Introduction	Visual Index	2
	Materials and Finishes	5
	Knoll Textiles Matrix	6
	Spinneybeck Leather Application Process	9
	Care and Maintenance	10
Preconfigured	Preconfigured Patterns	11
Build-to-Spec	Build-to-Spec - Upper Components - Seats	24
	Build-to-Spec - Upper Components - Arms	30
	Build-to-Spec - Upper Components - Tables	32
	Build-to-Spec - Lower Components - Electrical	34
	Build-to-Spec - Lower Components - Beams	38
	Build-to-Spec - Lower Components - Legs	44
	Build-to-Spec - Electrical	45
Alpha-Numeric Index		48
Selling Policy		49

Product	Preconfigured Patterns			
Seating	Single seat, no back	Single seat, with back	Armchair	
				
	Two-seat bench	Two-seat armless settee	Settee	
				
	Backless seat with table	Seat with back and table	Seat with back and right arm and table	Seat with back and left arm and table
				
	Three seat bench	Three seat armless sofa	Three seat sofa	
				
	Two seat bench and table	Two seat armless settee and table	Two-seat sofa with backs, right arm and end table	Two-seat sofa with arms and middle table
				
	Two-seat sofa with backs, left arm and table	Three-seat chaise, left arm	Three-seat chaise, right arm	
				
	L shaped sofa	L shaped sofa with corner table		
				

Product	Build-to-Spec: Upper Components			
Seats	Straight seat without back, no arms	Straight seat without back, right low arm	Straight seat without back, left low arm	Straight seat with back, no arms
				
	Straight seat with back, right high arm	Straight seat with back, right low arm	Straight seat with back, left high arm	Straight seat with back, left low arm
				
	Straight 90° corner seat with back, right	Straight 90° corner seat with back, left	Straight lounge chair with high arm	Straight lounge chair with low arm
				
Arm	Intermediate arm			
				
Tables	Low Table, no cut out	Low table, center-center cut out	Low table, side-center cut out	
				
Electrical	Electrical module for low tables, 3 receptacle, 3 power, cordset	Electrical module for low tables, 3 receptacle 3 power, hardwired	Electrical module for low tables, 3 receptacle 2 power 1 USB, cordset	Electrical module for low tables, 3 receptacle, 2 power 1 USB, hardwired
				
	Cord manager clip			
				

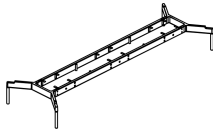
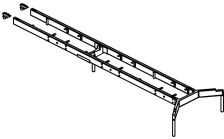
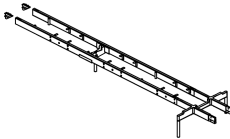
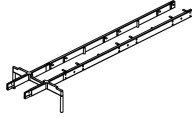
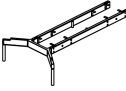
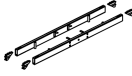
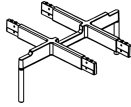
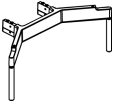
---

Product	<b>Build-to-Spec: Lower Components</b>		
Beams	Standard Beam 	Return Beam 	Intermediate Return Beam 
	Extension Beam 	Starter Beam 	Connector Beam 
Legs	Intermediate leg 	End leg 	Mid span leg 

---

**Fabric and Leather Upholstery**

Available in a range of KnollTextiles fabrics and Spinneybeck leathers, see pages 6-8 for approval. Customer's Own Material (COM) and Customer's Own Leather (COL) are available pending approval.

**Base Grade Information:**

Knoll Textiles Infinite K2263 is the base grade textile for Pixel Lounge. Choose K2263B for the base grade textile, followed by a two digit color.

Select one of the following:

**Code Description**

1	Sugar
2	Husk
3	Natural
4	Calm
5	Honeycomb
6	Cooper
7	Celery
8	Eucalyptus
9	Hillside
10	Feather
11	Raindrop
12	Pepper
13	Poppy
14	Wisteria
15	Blueberry
16	Midnight
17	Birch
18	Stonework
19	Nutmeg
20	Acorn
21	Mercury
22	Gunmetal

**Upholstery Reveal color**

WHI	White
BLK	Black
RED	Red
BLU	Blue
TAU	Taupe
GRY	Gray
GRN	Green
IVY	Ivory

Please note that the reveal option is available only on specific textiles.

Leather or vinyl upholstery will be finished with a double stitch, instead of the reveal.

**Table Top Finish**

118	Bright White, matte
114	Folkstone, matte
111	Black, matte
124	Medium Cherry
125	Natural Maple
126	Natural Cherry
127	Walnut
139	Light Ash
140	Warm Ash
141	Whitened Ash
142	Grey Ash
143	Classic Oak
144	Graphite Pear

**Edgeband**

118	Bright White, matte
114	Folkstone, matte
111	Black, matte
124	Medium Cherry
125	Natural Maple
126	Natural Cherry
127	Walnut
139	Light Ash
140	Warm Ash
141	Whitened Ash
142	Grey Ash
143	Classic Oak
144	Graphite Pear

**Electrical Module**

BK	Black case with black receptacles
WH	White case with white receptacles
111T	Black
118T	White
114T	Folkstone Grey
134T	Red

**Intermediate and End Leg**

AP	Polished Aluminum
111T	Jet Black
118T	Bright White

Textile Name	Grade	Direction	Part #	Pixel Lounge	Reveal option
Aegean	E	RR	K2074	■	■
Atelier	F	NR	K1607	○	○
Atlas	C	NR	K1236	○	○
Attire	B	RR	K2340	■	■
Belize	B	NR	K1165	○	○
Bella	I	RR	K2336	■	○
Boundary	B	NR	K1828	■	■
Brigadoon	B	NR	K2167	○	○
Buzz	D	RR	K2373	■	■
Calypso	B	NR	K2127	■	■
Cameo	B	NR	K1443	○	○
Cato	I	RR	KH800	■	○
Chain Link	D	NR	K2191	■	■
Chameleon	C	NR	K2372	○	○
Chic	I	NR	K2351	○	○
Classic Boucle	C	RR	K162	■	■
Code	D	NR	K2251	○	○
Color Field	C	NR	K2226	■	○
Commuter Cloth	A	NR	K1778	○	○
Crossroad	A	RR	K2085	■	■
Dapper	G	NR	K2338	■	■
Delite	A	NR	K2026	○	○
Diamond Days	I	NR	K1756	○	○
Diva	B	RR	K2051	■	■
Dottie	B	RR	K2259	■	○
Doyenne	H	NR	K2353	■	■
Durand	C	NR	K1885	○	○
Entwine	C	NR	K2355	○	○
Essence	C	NR	K2059	○	○
Espana	V	NR	ES	■	○
Gala II	B	NR	K1520	○	○
Helios	B	NR	K2089	○	○
Hourglass	A	RR	K1523	■	■
Hudson	C	NR	K1765	○	○

■=Available

○ =Not Available

Textile Name	Grade	Direction	Part #	Pixel Lounge	Reveal option
Ikat Stripe	D	NR	K1701	○	○
Infinite	base-grade	NR	K2263B	■	■
In Step	I	NR	K2375	○	○
Island	D	NR	K2053	○	○
Journey	B	RR	K1806	■	■
Kaya CR	C	NR	K2122	○	○
Keaton	B	NR	K1596	■	■
Knoll Felt	B	RR	K1207	■	■
Lagos	C	NR	K2028	■	■
Little Devil	B	RR	K2112	■	■
Ludlow	B	RR	K1998	■	■
Melange	G	RR	K1882	■	■
Menagerie	D	NR	K1322	○	○
Nature Walk	E	NR	K2081	○	○
Overture	A	NR	K2169	○	○
Palisade	C	NR	K2030	○	○
Patchwork	C	NR	K2292	○	○
Petite Floral	G	NR	K2087	■	■
Ponder	A	NR	K2382	■	■
Prairie	B	NR	K1925	○	○
Premier	E	NR	K2294	■	○
Prep	A	NR	K1076	○	○
Pullman	C	NR	K2124	■	○
Radiance	B	NR	K1921	○	○
Riva	Y	NR	RA	■	○
Rivington	F	NR	K1080	■	■
Rush Hour	B	NR	K1824	■	■
Script	B	RR	WC2328	○	○
Shima	E	NR	K1467	○	○
Sonnet	A	RR	K1460	■	■
Spot On	C	RR	K1324	■	■
Summit	B	NR	K2020	○	○
Sutton	B	NR	K1750	○	○

■ = Available

○ = Not Available



Textile Name	Grade	Direction	Part #	Pixel Lounge	Reveal option
Tabloid	B	NR	K2023	○	○
Tempest	E	RR	K2377	■	■
Tight Rope	C	NR	K1798	○	○
Tower Grid	C	NR	K1887	○	○
Twist Tie	H	NR	K2264	○	○
Ultrasuede	G	NR	K1021	○	○
Venue	B	NR	K1558	○	○
Velluto Pelle	V	NR	VP	■	○
Vibe II	C	NR	K2154	○	○
Vice Versa	E	NR	K2361	■	■
Volo	U	NR	VO	■	○
Westwood	B	NR	K1949	○	○
Wild Thing	B	NR	K2240	○	○
Whip	E	NR	K1386	○	○
Wit	C	NR	K2050	○	○
Woodland	D	NR	K2049	■	■

■ = Available

○ = Not Available

Spinneybeck leathers are made from the top 2% of the world's finest hides, inspected numerous times during production.

After tanning, all Spinneybeck leathers are drum-dyed, a time-consuming procedure which ensures color penetration throughout the hide. Then each hide is finished in the manner which will best bring out its individual character.

Spinneybeck leathers are all full-grain aniline drum-dyed products imported from Italy.

The following is a list of Spinneybeck leathers. Leathers are grouped into five price categories referred to as "grades." The selection of approved leathers varies by product. Please refer to the application approvals matrix for more information.

Square footage requirements for Customer's Own Leather (COL) are listed on each product's pricing page. Please refer to COM Seating Process Overview for further information regarding COL.

For further information, call Spinneybeck at 1 800 482-7777.

### Grades

#### U

Vicenza  
Volo

### Characteristics

Finished cowhide, corrected grain that is slightly raised.  
Finished cowhide, corrected grain, slightly raised grain texture.

#### V

Acqua  
Andes  
Embossed  
Tipped  
España  
Hand Tipped  
Maremma  
Velluto Pelle

Water-repellent finished cowhide, corrected grain, slightly raised grain texture.  
Slightly pronounced grain, finished cowhide and enhanced grain.  
Corrected grain, aniline dyed, two-tone, heavily finished leathers breathable protective finish.  
Smooth, tight grain cowhide; breathable, protective finish, enhanced grain.  
Two-toned leather, lightly finished cowhide, pronounced pebble grain texture.  
Full grain textured suede with impregnated soil-resistant treatment.  
Slightly pronounced grain, finished cowhide and enhanced grain.

#### W

Alaska  
Amazon  
Antique  
Derby  
Forte  
Lucente  
Sabrina

Pearlized-iridescent protective finish cowhide, full grain with smooth texture.  
Mid-weight, full grain cowhide; colors of the Amazonian jungle, raised grain texture.  
Smooth tight grain cowhide, lightly antiqued to produce an elegant patina, enhanced grain.  
Combination-tanned cowhide; full grain, lightly finished and raised grain texture.  
High performance, full grain leather with slightly pronounced grain texture.  
Smooth, very tight grain cowhide; subtle sheen; light casein finish.  
Smooth, tight and full grain cowhide with a breathable protective finish.

#### X

Ducale  
Ducale Velour

Embossed shrunken grain cowhide with protective finish, full grain.  
Full grain-sueded cowhide, embossed shrunken grain, scotch-guarded.

#### Y

Capri  
Cervo  
Copenhagen  
Distressed  
Lucca  
Marissa  
Portofino  
Riva  
Saddle

Chrome-free, light protective finish, full grain cowhide.  
Full aniline, cowhide, pronounced grain texture, extremely soft and supple hand.  
Full aniline, 100% vegetable tanned leather, full grain.  
Aniline-dyed, paraffin wax final ironing process with a smooth finish, and full grain.  
Grain sueded, aniline dyed, velvety suede surface.  
Grain-sueded cowhide, smooth suede grain with soil resistant treatment.  
Full grain, lightly finished cowhide with a pronounced raised texture.  
Slightly pronounced grain texture, water-repellent, full grain.  
Full aniline, smooth very tight grain surface takes on a rich patina over time.

---

**Fabric Surfaces**

A regular maintenance program will significantly lessen soil and dirt build up or staining. Cleaning is particularly important in areas adjacent to air conditioning or ventilation systems. • Avoid excessive heat or moisture. Never allow fabric surfaces to become wet inside the core. Room temperature should be maintained 50-85 degrees; humidity between 20-50%.

- Avoid contact with sharp edges which could puncture the surface.
- Do not handle fabric more than necessary. Avoid bending or flexing the surface.
- Grease or oil should be wiped off immediately. Remove excess grease or oil by blotting. Use hot water and mild soap to remove any remaining residue.
- Whenever possible, clean only with warm water and mild soap. Use caution when applying cleaning agents, particularly those that contain alcohol, strong alkalis, or solvents. These ingredients may react to backing or adhesives used. Always test cleaning agents in an inconspicuous place first.

**Knoll Textiles fabrics**

See Knoll Textiles website for detailed cleaning and care instructions. Wipe all spills immediately. Brush and vacuum every three to four months. Use a foam upholstery cleaner as directed semi-annually or more frequently, if necessary. Try a hidden area to test for color fastness.





**Spinneybeck Leathers**

Leathers develop a patina with age. Wipe all spills immediately. Do not use harsh cleaners, wax or oils, which will clog pores. Periodically wipe with a damp cloth. See [spinneybeck.com](http://spinneybeck.com) for detailed cleaning and care instructions and to purchase leather maintenance kits and ink remover.

# Preconfigured Patterns

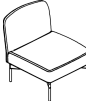
Pixel Lounge

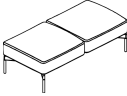
## *Fabric* by Marc Krusin





description	w	d	h	pattern no.	Base Grade	A	COM B	C	D	E	F	G	H	I
Single Seat, no back 	26 1/2"	26"	17"	<b>PLK1</b>	\$1,875.	\$1,913.	\$1,971.	\$2,032.	\$2,083.	\$2,125.	\$2,194.	\$2,231.	\$2,280.	\$2,441.
Single Seat with back 	26 1/2"	32"	29 1/2"	<b>PLK2</b>	2,703.	2,771.	2,870.	2,977.	3,066.	3,137.	3,257.	3,321.	3,404.	3,687.
Armchair 	31 1/2"	32"	29 1/2"	<b>PLK3</b>	4,012.	4,133.	4,309.	4,500.	4,655.	4,783.	4,995.	5,109.	5,259.	5,759.
Two seat bench 	52 1/2"	26"	17"	<b>PLK4</b>	3,084.	3,161.	3,275.	3,400.	3,501.	3,584.	3,722.	3,796.	3,894.	4,219.
Two seat armless settee 	52 3/4"	32"	29 1/2"	<b>PLK5</b>	4,742.	4,877.	5,074.	5,290.	5,464.	5,608.	5,847.	5,974.	6,143.	6,706.

Order Code	Specification Information	Application Notes	Construction
<i>Example:</i> <b>PLK1-AP-K20265-ORA</b>	<b>To order please specify:</b>	<b>Upholstery / COM information:</b>	Upholstery seats are constructed of high-density foam, wrapped in textile or leather, with a plywood bottom for stability. Upholstery backs and arms are constructed of high-density foam molded over a steel frame.
<b>PL</b> Pixel Lounge	1. Pattern Number	Prices shown include fabric or leather upholstery. Contact your Knoll representative for colors. Only approved Knoll Textiles and Spinneybeck leathers may be ordered. Customer's Own Materials available pending approval. Please note that leathers and vinyls will experience slight puckering around the corners. This will not detract from the beauty and quality of the upholstery.	Beam components are constructed of steel tubing and are shipped knocked-down, to be assembled on-site with included hardware.
<b>K</b> Preconfigured Pattern	2. Leg finish		
<b>1</b> Seating Assembly	3. Textile		
<b>AP</b> Polished Aluminum	4. Reveal color		
<b>K20265</b> Delite, Parrot	Note: Reveal option not available on leather or vinyl upholstery.		
<b>ORA</b> Reveal Color	<b>Base Grade</b> Knoll Textiles Infinite K2263 is the base grade textile for Pixel Lounge. Please refer to Materials and Finishes page 5 for specification details.		

# Preconfigured Patterns

Pixel Lounge

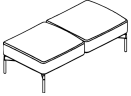
## Leather by Marc Krusin

description	w	d	h	pattern no.	COL U	V	W	X	Y
Single Seat, no back 	26 1/2"	26"	17"	<b>PLK1</b>	\$2,674.	\$2,986.	\$3,390.	\$3,502.	\$3,613.
Single Seat with back 	26 1/2"	32"	29 1/2"	<b>PLK2</b>	4,080.	4,621.	5,319.	5,514.	5,708.
Armchair 	31 1/2"	32"	29 1/2"	<b>PLK3</b>	6,458.	7,417.	8,659.	9,006.	9,350.
Two seat bench 	52 1/2"	26"	17"	<b>PLK4</b>	4,679.	5,305.	6,113.	6,337.	6,558.
Two seat armless settee 	52 3/4"	32"	29 1/2"	<b>PLK5</b>	7,493.	8,574.	9,972.	10,362.	10,747.

Order Code	Specification Information	Application Notes	Construction
<i>Example:</i> <b>PLK1-AP-VOBLCK</b>	<b>To order please specify:</b>	<b>Upholstery / COM information:</b>	Upholstery seats are constructed of high-density foam, wrapped in textile or leather, with a plywood bottom for stability. Upholstery backs and arms are constructed of high-density foam molded over a steel frame.
<b>PL</b> Pixel Lounge	1. Pattern Number	Prices shown include fabric or leather upholstery. Contact your Knoll representative for colors. Only approved KnollTextiles and Spinneybeck leathers may be ordered.	Beam components are constructed of steel tubing and are shipped knocked-down, to be assembled on-site with included hardware.
<b>K</b> Preconfigured Pattern	2. Leg finish	Customer's Own Materials available pending approval.	
<b>1</b> Single Seat, no back	3. Leather	Please note that leathers and vinyls will experience slight puckering around the corners. This will not detract from the beauty and quality of the upholstery.	
<b>AP</b> Polished Aluminum	Note: Reveal option not available on leather or vinyl upholstery.		
<b>VOBLCK</b> Volo, Black			

Preconfigured Patterns  
*Fabric*  
*by Marc Krusin*

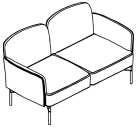
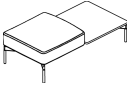
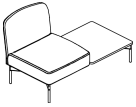
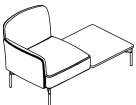
description	w	d	h	pattern no.	Base Grade	A	COM B	C	D	E	F	G	H	I
Settee 	57 1/2"	32"	29 1/2"	<b>PLK6</b>	\$6,034.	\$6,216.	\$6,480.	\$6,766.	\$6,999.	\$7,190.	\$7,509.	\$7,679.	\$7,758.	\$8,654.
Backless seat with table 	52 1/4"	26"	17"	<b>PLK7</b>	2,391.	2,429.	2,486.	2,548.	2,598.	2,640.	2,710.	2,746.	2,795.	2,958.
Seat with back and table 	52 1/4"	32"	29 1/2"	<b>PLK8</b>	3,220.	3,288.	3,387.	3,495.	3,581.	3,653.	3,771.	3,835.	3,921.	4,202.
Seat with back and right arm and table 	54 1/2"	32"	29 1/2"	<b>PLK9</b>	3,866.	3,957.	4,087.	4,232.	4,347.	4,444.	4,603.	4,688.	4,800.	5,175.

Order Code	Specification Information	Application Notes	Construction
<i>Example:</i> <b>PLK6-AP-K20265-ORA</b>	<b>To order please specify:</b>	<b>Upholstery / COM information:</b>	Upholstery seats are constructed of high-density foam, wrapped in textile or leather, with a plywood bottom for stability. Upholstery backs and arms are constructed of high-density foam molded over a steel frame.
<b>PL</b> Pixel Lounge	1. Pattern Number	Prices shown include fabric or leather upholstery. Contact your Knoll representative for colors. Only approved Knoll Textiles and Spinneybeck leathers may be ordered.	Beam components are constructed of steel tubing and are shipped knocked-down, to be assembled on-site with included hardware.
<b>K</b> Preconfigured	2. Leg finish	Customer's Own Materials available pending approval.	
<b>6</b> Settee	3. Textile	Please note that leathers and vinyls will experience slight puckering around the corners. This will not detract from the beauty and quality of the upholstery.	
<b>AP</b> Polished Aluminum	4. Reveal color		
<b>K20265</b> Delite, Parrot	5. Table top finish		
<b>ORA</b> Reveal Color	6. Edgeband finish		
<b>Y</b> No cut out	7. Cut out options		
	<b>Cutout options: (\$30 list per cutout)</b>		
	Y = No cutouts		
	CC = 3 receptacle center-center		
	CS = 3 receptacle center-side		
<b>Base Grade</b> Knoll Textiles Infinite K2263 is the base grade textile for Pixel Lounge. Please refer to Materials and Finishes page 5 for specification details.	Note: Reveal option not available on leather or vinyl upholstery.		

# Preconfigured Patterns

Pixel Lounge

## Fabric

by Marc Krusin

description	w	d	h	pattern no.	Base	COM								
					Grade	A	B	C	D	E	F	G	H	I
Seat with back and left arm and table	54 1/2"	32"	29 1/2"	<b>PLK10</b>	\$3,866.	\$3,957.	\$4,087.	\$4,232.	\$4,347.	\$4,444.	\$4,603.	\$4,688.	\$4,800.	\$5,175.

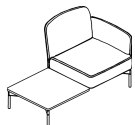

Order Code	Specification Information	Application Notes	Construction
<i>Example:</i> <b>PLK6-AP-K20265-ORA</b>	<b>To order please specify:</b>	<b>Upholstery / COM information:</b>	Upholstery seats are constructed of high-density foam, wrapped in textile or leather, with a plywood bottom for stability. Upholstery backs and arms are constructed of high-density foam molded over a steel frame.
<b>PL</b> Pixel Lounge	1. Pattern Number	Prices shown include fabric or leather upholstery. Contact your Knoll representative for colors. Only approved Knoll Textiles and Spinneybeck leathers may be ordered. Customer's Own Materials available pending approval. Please note that leathers and vinyls will experience slight puckering around the corners. This will not detract from the beauty and quality of the upholstery.	Beam components are constructed of steel tubing and are shipped knocked-down, to be assembled on-site with included hardware.
<b>K</b> Preconfigured	2. Leg finish		
<b>6</b> Settee	3. Textile		
<b>AP</b> Polished Aluminum	4. Reveal color		
<b>K20265</b> Delite, Parrot	5. Table top finish		
<b>ORA</b> Reveal Color	6. Edgeband finish		
<b>Y</b> No cut out	7. Cut out options		
	<b>Cutout options: (\$30 list per cutout)</b>		
	Y = No cutouts		
	CC = 3 receptacle center-center		
	CS = 3 receptacle center-side		

### Base Grade

Knoll Textiles Infinite K2263 is the base grade textile for Pixel Lounge. Please refer to Materials and Finishes page 5 for specification details.

Note: Reveal option not available on leather or vinyl upholstery.

# Preconfigured Patterns

Pixel Lounge

## Leather by Marc Krusin

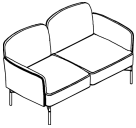
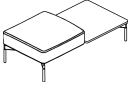
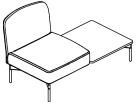
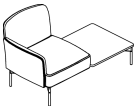
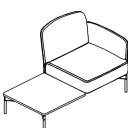
description	w	d	h	pattern no.	COL U	V	W	X	Y
Settee 	57 1/2"	32"	29 1/2"	<b>PLK6</b>	\$9,712.	\$11,150.	\$13,015.	\$13,534.	\$14,048.
Backless seat with table 	52 1/4"	26"	17"	<b>PLK7</b>	3,189.	3,501.	3,904.	4,018.	4,128.
Seat with back and table 	52 1/4"	32"	29 1/2"	<b>PLK8</b>	4,594.	5,136.	5,834.	6,030.	6,223.
Seat with back and right arm and table 	54 1/2"	32"	29 1/2"	<b>PLK9</b>	5,704.	6,425.	7,356.	7,615.	7,873.
Seat with back and left arm and table 	54 1/2"	32"	29 1/2"	<b>PLK10</b>	5,704.	6,425.	7,356.	7,615.	7,873.

Order Code	Specification Information	Application Notes	Construction
<i>Example:</i> <b>PLK6-AP-VOBLCK</b>	<b>To order please specify:</b>	<b>Upholstery / COM information:</b>	Upholstery seats are constructed of high-density foam, wrapped in textile or leather, with a plywood bottom for stability. Upholstery backs and arms are constructed of high-density foam molded over a steel frame.
<b>PL</b> Pixel Lounge	1. Pattern Number	Prices shown include fabric or leather upholstery. Contact your Knoll representative for colors.	Beam components are constructed of steel tubing and are shipped knocked-down, to be assembled on-site with included hardware.
<b>K</b> Preconfigured	2. Leg finish	Only approved Knoll Textile and Spinneybeck leathers may be ordered.	
<b>6</b> Settee	3. Leather	Customer's Own Materials available pending approval.	Please note that leathers and vinyls will experience slight puckering around the corners. This will not detract from the beauty and quality of the upholstery.
<b>AP</b> Polished Aluminum	4. Table top finish		
<b>VOBLCK</b> Volo, Black	5. Edgeband finish		
	6. Cut out options		
	<b>Cutout options: (\$30 list per cutout)</b>		
	Y = No cutouts		
	CC = 3 receptacle center-center		
	CS = 3 receptacle center-side		
	Note: Reveal option not available on leather or vinyl upholstery.		



# Preconfigured Patterns

Pixel Lounge

*Fabric*

*by Marc Krusin*

description	w	d	h	pattern no.	Base Grade	A	COM B	C	D	E	F	G	H	I
Three seat bench	78 <sup>3</sup> / <sub>4</sub> "	26"	17"	<b>PLK11</b>	\$4,271.	\$4,389.	\$4,561.	\$4,746.	\$4,899.	\$5,024.	\$5,231.	\$5,342.	\$5,487.	\$5,974.

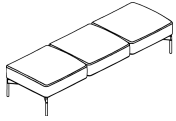

Three seat armless Sofa	78 <sup>3</sup> / <sub>4</sub> "	32"	29 <sup>1</sup> / <sub>2</sub> "	<b>PLK12</b>	6,758.	6,963.	7,259.	7,580.	7,844.	8,060.	8,416.	8,610.	8,863.	9,706.
-------------------------	----------------------------------	-----	----------------------------------	--------------	--------	--------	--------	--------	--------	--------	--------	--------	--------	--------

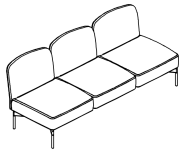

Three seat sofa	83 <sup>1</sup> / <sub>2</sub> "	32"	29 <sup>1</sup> / <sub>2</sub> "	<b>PLK13</b>	8,052.	8,302.	8,662.	9,058.	9,379.	9,641.	10,080.	10,314.	10,623.	11,653.
-----------------	----------------------------------	-----	----------------------------------	--------------	--------	--------	--------	--------	--------	--------	---------	---------	---------	---------

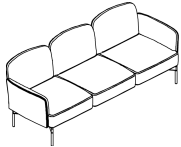

Order Code	Specification Information	Application Notes	Construction
<i>Example:</i> <b>PLK11-AP-K20265-ORA</b>	<b>To order please specify:</b> 1. Pattern Number 2. Leg finish 3. Textile 4. Reveal color	<b>Upholstery / COM information:</b> Prices shown include fabric or leather upholstery. Contact your Knoll representative for colors. Only approved Knoll Textiles and Spinneybeck leathers may be ordered. Customer's Own Materials available pending approval. Please note that leathers and vinyls will experience slight puckering around the corners. This will not detract from the beauty and quality of the upholstery.	Upholstery seats are constructed of high-density foam, wrapped in textile or leather, with a plywood bottom for stability. Upholstery backs and arms are constructed of high-density foam molded over a steel frame.  Beam components are constructed of steel tubing and are shipped knocked-down, to be assembled on-site with included hardware.
<b>PL</b> Pixel Lounge	Note: Reveal option not available on leather or vinyl upholstery.		
<b>K</b> Preconfigured	<b>Base Grade</b> Knoll Textiles Infinite K2263 is the base grade textile for Pixel Lounge. Please refer to Materials and Finishes page 5 for specification details.		
<b>11</b> Three Seat Bench			
<b>AP</b> Polished Aluminum			
<b>K20265</b> Delite, Parrot			
<b>ORA</b> Reveal Color			

# Preconfigured Patterns

Pixel Lounge

## Leather by Marc Krusin

description	w	d	h	pattern no.	COL U	V	W	X	Y
Three seat bench	78 <sup>3</sup> / <sub>4</sub> "	26"	17"	<b>PLK11</b>	\$6,667.	\$7,605.	\$8,813.	\$9,153.	\$9,485.

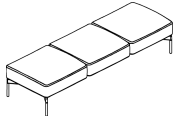

Three seat armless Sofa	78 <sup>3</sup> / <sub>4</sub> "	32"	29 <sup>1</sup> / <sub>2</sub> "	<b>PLK12</b>	10,888.	12,509.	14,604.	15,189.	15,767.
----------------------------	----------------------------------	-----	----------------------------------	--------------	---------	---------	---------	---------	---------

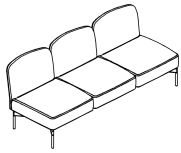

Three seat sofa	83 <sup>1</sup> / <sub>2</sub> "	32"	29 <sup>1</sup> / <sub>2</sub> "	<b>PLK13</b>	13,105.	15,086.	17,647.	18,362.	19,068.
-----------------	----------------------------------	-----	----------------------------------	--------------	---------	---------	---------	---------	---------

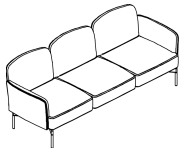

Order Code	Specification Information	Application Notes	Construction
<i>Example:</i> <b>PLK11-AP-VOBLCK</b>	<b>To order please specify:</b>	<b>Upholstery / COM information:</b>	Upholstery seats are constructed of high-density foam, wrapped in textile or leather, with a plywood bottom for stability. Upholstery backs and arms are constructed of high-density foam molded over a steel frame.
<b>PL</b> Pixel Lounge	1. Pattern Number	Prices shown include fabric or leather upholstery. Contact your Knoll representative for colors. Only approved KnollTextiles and Spinneybeck leathers may be ordered.	Beam components are constructed of steel tubing and are shipped knocked-down, to be assembled on-site with included hardware.
<b>K</b> Preconfigured	2. Leg finish	Customer's Own Materials available pending approval.	
<b>11</b> Three Seat Bench	3. Leather	Please note that leathers and vinyls will experience slight puckering around the corners. This will not detract from the beauty and quality of the upholstery.	
<b>AP</b> Polished Aluminum	Note: Reveal option not available on leather or vinyl upholstery.		
<b>VOBLCK</b> Volo, Black			

Preconfigured Patterns  
*Fabric*  
*by Marc Krusin*

description	w	d	h	pattern no.	Base Grade	COM								
						A	B	C	D	E	F	G	H	I
Two seat bench and table	78 <sup>3</sup> / <sub>4</sub> "	26"	17"	<b>PLK14</b>	\$3,578.	\$3,657.	\$3,770.	\$3,896.	\$3,998.	\$4,080.	\$4,219.	\$4,291.	\$4,389.	\$4,715.

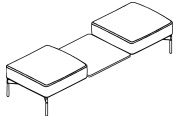

Two seat armless settee and table	78 <sup>3</sup> / <sub>4</sub> "	32"	29 <sup>1</sup> / <sub>2</sub> "	<b>PLK15</b>	5,237.	5,373.	5,569.	5,784.	5,961.	6,104.	6,343.	6,471.	6,640.	7,201.
-----------------------------------	----------------------------------	-----	----------------------------------	--------------	--------	--------	--------	--------	--------	--------	--------	--------	--------	--------

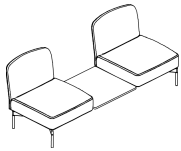

Two seat sofa with backs, right arm and end table	80 <sup>3</sup> / <sub>4</sub> "	32"	29 <sup>1</sup> / <sub>2</sub> "	<b>PLK16</b>	5,884.	6,042.	6,272.	6,524.	6,728.	6,896.	7,174.	7,325.	7,520.	8,176.
---	----------------------------------	-----	----------------------------------	--------------	--------	--------	--------	--------	--------	--------	--------	--------	--------	--------

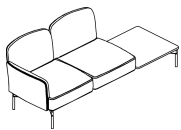

Two seat sofa with arms and middle table	83 <sup>1</sup> / <sub>2</sub> "	32"	29 <sup>1</sup> / <sub>2</sub> "	<b>PLK17</b>	6,531.	6,711.	6,973.	7,261.	7,495.	7,686.	8,004.	8,175.	8,399.	9,150.
--	----------------------------------	-----	----------------------------------	--------------	--------	--------	--------	--------	--------	--------	--------	--------	--------	--------

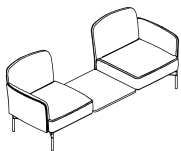

Order Code	Specification Information	Application Notes	Construction
<i>Example:</i> <b>PLK14-AP-K20265-ORA-118-118-Y</b>	<b>To order please specify:</b>	<b>Upholstery / COM information:</b>	Upholstery seats are constructed of high-density foam, wrapped in textile or leather, with a plywood bottom for stability. Upholstery backs and arms are constructed of high-density foam molded over a steel frame.
<b>PL</b> Pixel Lounge	1. Pattern Number	Prices shown include fabric or leather upholstery. Contact your Knoll representative for colors. Only approved Knoll Textiles and Spinneybeck leathers may be ordered.	Beam components are constructed of steel tubing and are shipped knocked-down, to be assembled on-site with included hardware.
<b>K</b> Preconfigured	2. Leg finish	Customer's Own Materials available pending approval.	
<b>14</b> Two Seat Bench and Table	3. Textile	Please note that leathers and vinyls will experience slight puckering around the corners. This will not detract from the beauty and quality of the upholstery.	
<b>AP</b> Polished Aluminum	4. Reveal color		
<b>K20265</b> Knoll Textiles	5. Table top finish		
<b>ORA</b> Reveal Color	6. Edgeband finish		
<b>118</b> Bright White Table top	7. Cut out options		
<b>118</b> Bright White Edge	<b>Cutout options: (\$30 list per cutout)</b>		
<b>Y</b> No cut out	Y = No cutouts		
	CC = 3 receptacle center-center		
	CS = 3 receptacle center-side		

Note: Reveal option not available on leather or vinyl upholstery.

**Base Grade**  
 Knoll Textiles Infinite K2263 is the base grade textile for Pixel Lounge. Please refer to Materials and Finishes page 5 for specification details.

# Preconfigured Patterns

Pixel Lounge

## Leather by Marc Krusin

description	w	d	h	pattern no.	COL U	V	W	X	Y
Two seat bench and table	78 <sup>3</sup> / <sub>4</sub> "	26"	17"	<b>PLK14</b>	\$5,175.	\$5,801.	\$6,606.	\$6,833.	\$7,055.

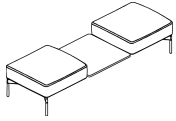

Two seat armless settee and table	78 <sup>3</sup> / <sub>4</sub> "	32"	29 <sup>1</sup> / <sub>2</sub> "	<b>PLK15</b>	7,990.	9,070.	10,468.	10,859.	11,242.
-----------------------------------	----------------------------------	-----	----------------------------------	--------------	--------	--------	---------	---------	---------

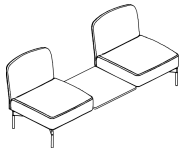

Two seat sofa with backs, right arm and end table	80 <sup>3</sup> / <sub>4</sub> "	32"	29 <sup>1</sup> / <sub>2</sub> "	<b>PLK16</b>	9,100.	10,360.	11,989.	12,443.	12,893.
---	----------------------------------	-----	----------------------------------	--------------	--------	---------	---------	---------	---------

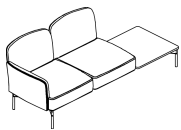

Two seat sofa with arms and middle table	83 <sup>1</sup> / <sub>2</sub> "	32"	29 <sup>1</sup> / <sub>2</sub> "	<b>PLK17</b>	10,207.	11,647.	13,508.	14,030.	14,542.
--	----------------------------------	-----	----------------------------------	--------------	---------	---------	---------	---------	---------

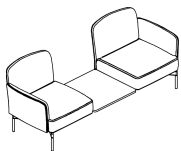

Order Code	Specification Information	Application Notes	Construction
<i>Example:</i> <b>PLK7-AP-VOBLCK-118-118-Y</b>	<b>To order please specify:</b>	<b>Upholstery / COM information:</b>	Upholstery seats are constructed of high-density foam, wrapped in textile or leather, with a plywood bottom for stability. Upholstery backs and arms are constructed of high-density foam molded over a steel frame.
<b>PL</b> Pixel Lounge	1. Pattern Number	Prices shown include fabric or leather upholstery. Contact your Knoll representative for colors. Only approved Knoll Textiles and Spinneybeck leathers may be ordered.	Beam components are constructed of steel tubing and are shipped knocked-down, to be assembled on-site with included hardware.
<b>K</b> Preconfigured	2. Leg finish	Customer's Own Materials available pending approval.	
<b>1</b> Seating Assembly	3. Leather	Please note that leathers and vinyls will experience slight puckering around the corners. This will not detract from the beauty and quality of the upholstery.	
<b>AP</b> Polished Aluminum	4. Table top finish		
<b>VOBLCK</b> Volo, Black	5. Edgeband finish		
<b>118</b> Bright White Table Top	6. Cut out options		
<b>118</b> Bright White Edge	<b>Cutout options: (\$30 list per cutout)</b>		
<b>Y</b> No cut out	Y = No cutouts		
	CC = 3 receptacle center-center		
	CS = 3 receptacle center-side		
	Note: Reveal option not available on leather or vinyl upholstery.		

# Preconfigured Patterns

Pixel Lounge

*Fabric*

*by Marc Krusin*

description	w	d	h	pattern no.	Base Grade	COM								
						A	B	C	D	E	F	G	H	I
Two seat sofa with backs, left arm and table	80 3/4"	32"	29 1/2"	<b>PLK18</b>	\$5,882.	\$6,042.	\$6,272.	\$6,524.	\$6,728.	\$6,896.	\$7,174.	\$7,321.	\$7,519.	\$8,176.

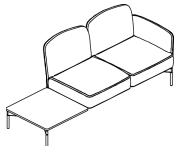

Three seat chaise, right arm	81 1/4"	32"	29 1/2"	<b>PLK19</b>	8,046.	8,304.	8,675.	9,081.	9,413.	9,685.	10,134.	10,377.	10,695.	11,756.
------------------------------	---------	-----	---------	--------------	--------	--------	--------	--------	--------	--------	---------	---------	---------	---------

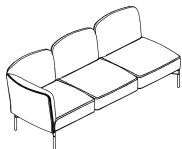

Three seat chaise, left arm	81 1/4"	32"	29 1/2"	<b>PLK20</b>	8,046.	8,304.	8,675.	9,081.	9,413.	9,685.	10,134.	10,377.	10,695.	11,756.
-----------------------------	---------	-----	---------	--------------	--------	--------	--------	--------	--------	--------	---------	---------	---------	---------

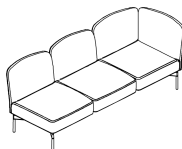

## Order Code

<i>Example:</i>	<b>PLK19-AP-K20265-ORA</b>
<b>PL</b>	Pixel Lounge
<b>K</b>	Preconfigured
<b>19</b>	Three Seat Chaise, Right arm
<b>AP</b>	Polished Aluminum
<b>K20265</b>	Delite, Parrot
<b>ORA</b>	Reveal Color

## Specification Information

### To order please specify:

1. Pattern Number
2. Leg finish
3. Textile
4. Reveal color
5. Table top finish
6. Edgeband finish
7. Cut out options

### Cutout options: (\$30 list per cutout)

Y = No cutouts  
 CC = 3 receptacle center-center  
 CS = 3 receptacle center-side

Note: Reveal option not available on leather or vinyl upholstery.

### Base Grade

Knoll Textiles Infinite K2263 is the base grade textile for Pixel Lounge. Please refer to Materials and Finishes page 5 for specification details.

## Application Notes

### Upholstery / COM information:

Prices shown include fabric or leather upholstery. Contact your Knoll representative for colors. Only approved KnollTextiles and Spinneybeck leathers may be ordered.

Customer's Own Materials available pending approval. Please note that leathers and vinyls will experience slight puckering around the corners. This will not detract from the beauty and quality of the upholstery.

## Construction

Upholstery seats are constructed of high-density foam, wrapped in textile or leather, with a plywood bottom for stability. Upholstery backs and arms are constructed of high-density foam molded over a steel frame.

Beam components are constructed of steel tubing and are shipped knocked-down, to be assembled on-site with included hardware.

# Preconfigured Patterns

Pixel Lounge

## Leather by Marc Krusin

description	w	d	h	pattern no.	COL U	V	W	X	Y
Two seat sofa with backs, left arm and table	80 <sup>3</sup> / <sub>4</sub> "	32"	29 <sup>1</sup> / <sub>2</sub> "	<b>PLK18</b>	\$9,099.	\$10,360.	\$11,989.	\$12,443.	\$12,893.

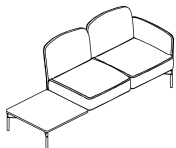

Three seat chaise, right arm	81 <sup>1</sup> / <sub>4</sub> "	32"	29 <sup>1</sup> / <sub>2</sub> "	<b>PLK19</b>	13,220.	15,260.	17,896.	18,635.	19,362.
------------------------------	----------------------------------	-----	----------------------------------	--------------	---------	---------	---------	---------	---------

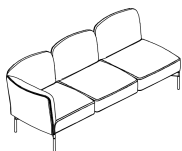

Three seat chaise, left arm	81 <sup>1</sup> / <sub>4</sub> "	32"	29 <sup>1</sup> / <sub>2</sub> "	<b>PLK20</b>	13,220.	15,260.	17,896.	18,635.	19,362.
-----------------------------	----------------------------------	-----	----------------------------------	--------------	---------	---------	---------	---------	---------

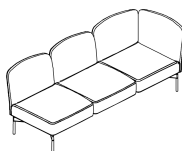

Order Code	Specification Information	Application Notes	Construction
<i>Example:</i> <b>PLK19-AP-VOBLCK</b>			
<b>PL</b> Pixel Lounge	<b>To order please specify;</b>	<b>Upholstery / COM information:</b>	Upholstery seats are constructed of high-density foam, wrapped in textile or leather, with a plywood bottom for stability. Upholstery backs and arms are constructed of high-density foam molded over a steel frame.
<b>K</b> Preconfigured	1. Pattern Number	Prices shown include fabric or leather upholstery. Contact your Knoll representative for colors. Only approved KnollTextiles and Spinneybeck leathers may be ordered.	Beam components are constructed of steel tubing and are shipped knocked-down, to be assembled on-site with included hardware.
<b>19</b> Three Seat Chaise, right arm	2. Leg finish	Customer's Own Materials available pending approval.	
<b>AP</b> Polished Aluminum	3. Leather	Please note that leathers and vinyls will experience slight puckering around the corners. This will not detract from the beauty and quality of the upholstery.	
<b>VOBLCK</b> Volo, Black	<b>Cutout options: (\$30 list per cutout)</b>		
	Y = No cutouts		
	CC = 3 receptacle center-center		
	CS = 3 receptacle center-side		
	Note: Reveal option not available on leather or vinyl upholstery.		

Preconfigured Patterns  
*Fabric*  
*by Marc Krusin*

description	w	d	h	pattern no.	Base Grade	COM								
						A	B	C	D	E	F	G	H	I
L Shaped sofa	84 1/4"	84 1/4"	29 1/2"	<b>PLK21</b>	\$12,581.	\$12,974.	\$13,543.	\$14,164.	\$14,671.	\$15,086.	\$15,775.	\$16,145.	\$16,632.	\$18,256.

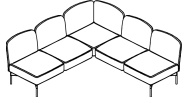

L Shaped sofa with corner table	84 1/4"	84 1/4"	29 1/2"	<b>PLK22</b>	9,772.	10,044.	10,437.	10,868.	11,219.	11,506.	11,984.	12,240.	12,576.	13,702.
---------------------------------	---------	---------	---------	--------------	--------	---------	---------	---------	---------	---------	---------	---------	---------	---------

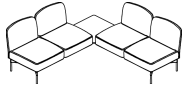

Order Code	Specification Information	Application Notes	Construction
<i>Example:</i> <b>PLK22-AP-K20265-ORA-118-118-Y</b>			
<b>PL</b> Pixel Lounge	<b>To order please specify;</b>	<b>Upholstery / COM information:</b>	Upholstery seats are constructed of high-density foam, wrapped in textile or leather, with a plywood bottom for stability. Upholstery backs and arms are constructed of high-density foam molded over a steel frame.
<b>K</b> Preconfigured	1. Pattern Number	Prices shown include fabric or leather upholstery. Contact your Knoll representative for colors. Only approved Knoll Textiles and Spinneybeck leathers may be ordered.	Beam components are constructed of steel tubing and are shipped knocked-down, to be assembled on-site with included hardware.
<b>22</b> L Shaped Sofa with corner table	2. Leg finish	Customer's Own Materials available pending approval.	
<b>AP</b> Polished Aluminum	3. Textile	Please note that leathers and vinyls will experience slight puckering around the corners. This will not detract from the beauty and quality of the upholstery.	
<b>K20265</b> Delite, Parrot	4. Reveal color		
<b>ORA</b> Reveal Color	5. Table top finish		
<b>118</b> Bright White Table top	6. Edgeband finish		
<b>118</b> Bright White Edge	7. Cut out options		
<b>Y</b> No cut out	<b>Cutout options: (\$30 list per cutout)</b>		
	Y = No cutouts		
	CC = 3 receptacle center-center		
	CS = 3 receptacle center-side		
	Note: Reveal option not available on leather or vinyl upholstery.		
	<b>Base Grade</b>		
	Knoll Textiles Infinite K2263 is the base grade textile for Pixel Lounge. Please refer to Materials and Finishes page 5 for specification details.		

# Preconfigured Patterns

Pixel Lounge

## Leather by Marc Krusin

description	w	d	h	pattern no.	COL U	V	W	X	Y
L Shaped sofa	84 1/4"	84 1/4"	29 1/2"	<b>PLK21</b>	\$20,508.	\$23,629.	\$27,662.	\$28,790.	\$29,902.

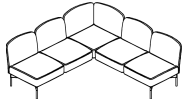

L Shaped sofa with corner table	84 1/4"	84 1/4"	29 1/2"	<b>PLK22</b>	15,278.	17,440.	20,231.	21,012.	21,784.
---------------------------------	---------	---------	---------	--------------	---------	---------	---------	---------	---------

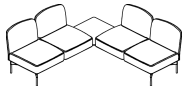

Order Code	Specification Information	Application Notes	Construction
<i>Example:</i> <b>PLK22-AP-VOBLCK-118-118-Y</b>	<b>To order please specify:</b>	<b>Upholstery / COM information:</b>	Upholstery seats are constructed of high-density foam, wrapped in textile or leather, with a plywood bottom for stability. Upholstery backs and arms are constructed of high-density foam molded over a steel frame.
<b>PL</b> Pixel Lounge	1. Pattern Number	Prices shown include fabric or leather upholstery. Contact your Knoll representative for colors. Only approved Knoll Textiles and Spinneybeck leathers may be ordered.	Beam components are constructed of steel tubing and are shipped knocked-down, to be assembled on-site with included hardware.
<b>K</b> Preconfigured	2. Leg finish	Customer's Own Materials available pending approval.	
<b>22</b> L Shaped Sofa with corner table	3. Leather	Please note that leathers and vinyls will experience slight puckering around the corners. This will not detract from the beauty and quality of the upholstery.	
<b>AP</b> Polished Aluminum	4. Table top finish		
<b>VOBLCK</b> Volo, Black	5. Edgeband finish		
<b>118</b> Bright White Table top	6. Cut out options		
<b>118</b> Bright White Edge	<b>Cutout options: (\$30 list per cutout)</b>		
<b>Y</b> No cut out	Y = No cutouts		
	CC = 3 receptacle center-center		
	CS = 3 receptacle center-side		
	Note: Reveal option not available on leather or vinyl upholstery.		



# Build-to-Spec - Upper Components - Seats

Pixel Lounge

## Fabric by Marc Krusin

description	w	d	h	pattern no.	Base Grade	COM								
						A	B	C	D	E	F	G	H	I
Straight seat without back no arms	26 1/2"	26"	8"	<b>PLS2NC</b>	\$1,026.	\$1,067.	\$1,123.	\$1,186.	\$1,236.	\$1,278.	\$1,346.	\$1,384.	\$1,432.	\$1,595.



Straight seat without back, low right arm	28 1/2"	26"	15"	<b>PLS2NAR</b>	1,608.	1,669.	1,756.	1,852.	1,929.	1,994.	2,101.	2,156.	2,231.	2,482.
--	---------	-----	-----	----------------	--------	--------	--------	--------	--------	--------	--------	--------	--------	--------



Straight seat without back, low left arm	28 1/2"	26"	15"	<b>PLS2NAL</b>	1,608.	1,669.	1,756.	1,852.	1,929.	1,994.	2,101.	2,156.	2,231.	2,482.
---	---------	-----	-----	----------------	--------	--------	--------	--------	--------	--------	--------	--------	--------	--------



Straight seat with back, no arms	26 1/2"	32"	20 1/2"	<b>PLS2BC</b>	1,856.	1,924.	2,023.	2,129.	2,218.	2,289.	2,410.	2,473.	2,557.	2,839.
-------------------------------------	---------	-----	---------	---------------	--------	--------	--------	--------	--------	--------	--------	--------	--------	--------



Order Code	Specification Information	Application Notes	Construction
<i>Example:</i> <b>PLS2NC-K20265-ORA</b>	<b>To order please specify:</b> 1. Pattern Number 2. Textile 3. Reveal color  Note: Reveal option not available on leather or vinyl upholstery.	<b>Upholstery / COM information:</b>  Prices shown include fabric or leather upholstery. Contact your Knoll representative for colors. Only approved Knoll Textiles and Spinneybeck leathers may be ordered.  Customer's Own Materials available pending approval. Please note that leathers and vinyls will experience slight puckering around the corners. This will not detract from the beauty and quality of the upholstery.	Upholstery seats are constructed of high-density foam, wrapped in textile or leather, with a plywood bottom for stability. Upholstery backs and arms are constructed of high-density foam molded over a steel frame.
<b>PL</b> Pixel Lounge			
<b>S</b> Seat			
<b>2</b> Straight			
<b>N</b> Seat no back			
<b>C</b> No arms			
<b>K20265</b> Delite, Parrot			
<b>ORA</b> Reveal color	<b>Base Grade</b> Knoll Textiles Infinite K2263 is the base grade textile for Pixel Lounge. Please refer to Materials and Finishes page 5 for specification details.		

# Build-to-Spec - Upper Components - Seats

Pixel Lounge

*Leather  
by Marc Krusin*

description	w	d	h	pattern no.	COL U	V	W	X	Y
Straight seat without back no arms	26 1/2"	26"	8"	<b>PLS2NC</b>	\$1,826.	\$2,139.	\$2,542.	\$2,655.	\$2,765.



Straight seat without back, low right arm	28 1/2"	26"	15"	<b>PLS2NAR</b>	2,854.	3,335.	3,955.	4,129.	4,300.
--	---------	-----	-----	----------------	--------	--------	--------	--------	--------



Straight seat without back, low left arm	28 1/2"	26"	15"	<b>PLS2NAL</b>	2,854.	3,335.	3,955.	4,129.	4,300.
---	---------	-----	-----	----------------	--------	--------	--------	--------	--------



Straight seat with back, no arms	26 1/2"	32"	20 1/2"	<b>PLS2BC</b>	3,233.	3,772.	4,472.	4,667.	4,859.
-------------------------------------	---------	-----	---------	---------------	--------	--------	--------	--------	--------



Order Code	Specification Information	Application Notes	Construction
<i>Example:</i> <b>PLS2NC-AU0615</b>	<b>To order please specify:</b>	<b>Upholstery / COM information:</b>	<b>Construction:</b>
<b>PL</b> Pixel Lounge	1. Pattern Number	Prices shown include fabric or leather upholstery. Contact your Knoll representative for colors.	Upholstery seats are constructed of high-density foam, wrapped in textile or leather, with a plywood bottom for stability. Upholstery backs and arms are constructed of high-density foam molded over a steel frame.
<b>S</b> Seat	2. Textile	Only approved Knoll Textile and Spinneybeck leathers may be ordered.	
<b>2</b> Straight	Note: Reveal option not available on leather or vinyl upholstery.	Customer's Own Materials available pending approval.	
<b>N</b> Seat no back		Please note that leathers and vinyls will experience slight puckering around the corners. This will not detract from the beauty and quality of the upholstery.	
<b>C</b> No arms			
<b>AU0615</b> Spinneybeck Leather Acqua Red Sea			

# Build-to-Spec - Upper Components - Seats

Pixel Lounge

## Fabric by Marc Krusin

description	w	d	h	pattern no.	Base		COM		C	D	E	F	G	H	I
					Grade	A	B								
Straight seat with back, right high arm	29 1/4"	32"	20 1/2"	<b>PLS2BARH</b>	\$2,584.	\$2,675.	\$2,806.	\$2,949.	\$3,067.	\$3,162.	\$3,321.	\$3,406.	\$3,519.	\$3,894.	



Straight seat with back, left high arm	29 1/4"	32"	20 1/2"	<b>PLS2BALH</b>	2,584.	2,675.	2,806.	2,949.	3,067.	3,162.	3,321.	3,406.	3,519.	3,894.
--	---------	-----	---------	-----------------	--------	--------	--------	--------	--------	--------	--------	--------	--------	--------



Straight seat with back, right low arm	28 1/2"	32"	20 1/2"	<b>PLS2BARL</b>	2,504.	2,594.	2,725.	2,869.	2,986.	3,081.	3,240.	3,327.	3,438.	3,812.
--	---------	-----	---------	-----------------	--------	--------	--------	--------	--------	--------	--------	--------	--------	--------



Straight seat with back, left low arm	28 1/2"	32"	20 1/2"	<b>PLS2BALL</b>	2,504.	2,594.	2,725.	2,869.	2,986.	3,081.	3,240.	3,327.	3,438.	3,812.
---------------------------------------	---------	-----	---------	-----------------	--------	--------	--------	--------	--------	--------	--------	--------	--------	--------



Order Code	Specification Information	Application Notes	Construction
<i>Example:</i> <b>PLS2BARH-K20265-ORA</b>	<b>To order please specify:</b> 1. Pattern Number 2. Textile 3. Reveal color  Note: Reveal option not available on leather or vinyl upholstery.	<b>Upholstery / COM information:</b> Prices shown include fabric or leather upholstery. Contact your Knoll representative for colors. Only approved Knoll Textiles and Spinneybeck leathers may be ordered. Customer's Own Materials available pending approval. Please note that leathers and vinyls will experience slight puckering around the corners. This will not detract from the beauty and quality of the upholstery.	Upholstery seats are constructed of high-density foam, wrapped in textile or leather, with a plywood bottom for stability. Upholstery backs and arms are constructed of high-density foam molded over a steel frame.
<b>PL</b> Pixel Lounge			
<b>S</b> Seat			
<b>2</b> Straight			
<b>BARH</b> Seat with back, right high arm			
<b>K20265</b> Delite, Parrot	<b>Base Grade</b> Knoll Textiles Infinite K2263 is the base grade textile for Pixel Lounge. Please refer to Materials and Finishes page 5 for specification details.		
<b>ORA</b> Reveal color			

# Build-to-Spec - Upper Components - Seats

Pixel Lounge

## Leather by Marc Krusin

description	w	d	h	pattern no.	COL U	V	W	X	Y
Straight seat with back, right high arm	29 1/4"	32"	20 1/2"	<b>PLS2BARH</b>	\$4,422.	\$5,142.	\$6,072.	\$6,333.	\$6,590.



Straight seat with back, left high arm	29 1/4"	32"	20 1/2"	<b>PLS2BALH</b>	4,422.	5,142.	6,072.	6,333.	6,590.
---	---------	-----	---------	-----------------	--------	--------	--------	--------	--------



Straight seat with back, right low arm	28 1/2"	32"	20 1/2"	<b>PLS2BARL</b>	4,342.	5,061.	5,992.	6,253.	6,509.
---	---------	-----	---------	-----------------	--------	--------	--------	--------	--------



Straight seat with back, left low arm	28 1/2"	32"	20 1/2"	<b>PLS2BALL</b>	4,342.	5,061.	5,992.	6,253.	6,509.
--	---------	-----	---------	-----------------	--------	--------	--------	--------	--------



Order Code	Specification Information	Application Notes	Construction
<i>Example:</i> <b>PLS2BARH-AU0615</b>	<b>To order please specify:</b>	<b>Upholstery / COM information:</b>	Upholstery seats are constructed of high-density foam, wrapped in textile or leather, with a plywood bottom for stability. Upholstery backs and arms are constructed of high-density foam molded over a steel frame.
<b>PL</b> Pixel Lounge	1. Pattern Number	Prices shown include fabric or leather upholstery. Contact your Knoll representative for colors. Only approved Knoll Textile and Spinneybeck leathers may be ordered.	
<b>S</b> Seat	2. Leather		
<b>2</b> Straight	Note: Reveal option not available on leather or vinyl upholstery.	Customer's Own Materials available pending approval.	
<b>BARH</b> Seat with back, right high arm		Please note that leathers and vinyls will experience slight puckering around the corners. This will not detract from the beauty and quality of the upholstery.	
<b>AU0615</b> Spinneybeck Acqua Red Sea			

# Build-to-Spec - Upper Components - Seats

Pixel Lounge

*Fabric*  
*by Marc Krusin*

description	w	d	h	pattern no.	Base Grade	A	COM B	C	D	E	F	G	H	I
Straight 90° corner seat with back, right arm	32"	32"	20 1/2"	<b>PLS2EBR</b>	\$3,143.	\$3,264.	\$3,440.	\$3,630.	\$3,786.	\$3,915.	\$4,127.	\$4,239.	\$4,389.	\$4,889.



Straight 90° corner seat with back, left arm	32"	32"	20 1/2"	<b>PLS2EBL</b>	3,143.	3,264.	3,440.	3,630.	3,786.	3,915.	4,127.	4,239.	4,389.	4,889.
--	-----	-----	---------	----------------	--------	--------	--------	--------	--------	--------	--------	--------	--------	--------



Straight seat with back, with high arms	32 3/4"	32"	20 1/2"	<b>PLS2LAH</b>	3,328.	3,448.	3,624.	3,815.	3,971.	4,098.	4,310.	4,425.	4,573.	5,074.
---	---------	-----	---------	----------------	--------	--------	--------	--------	--------	--------	--------	--------	--------	--------



Straight seat with back, with low arms	31 1/2"	32"	20 1/2"	<b>PLS2LAL</b>	3,164.	3,287.	3,461.	3,653.	3,809.	3,936.	4,149.	4,262.	4,413.	4,912.
--	---------	-----	---------	----------------	--------	--------	--------	--------	--------	--------	--------	--------	--------	--------



Order Code	Specification Information	Application Notes	Construction
<i>Example:</i> <b>PLS2EBR-K20265-ORA</b>	<b>To order please specify:</b> 1. Pattern Number 2. Textile 3. Reveal color  Note: Reveal option not available on leather or vinyl upholstery.	<b>Upholstery / COM information:</b> Prices shown include fabric or leather upholstery. Contact your Knoll representative for colors. Only approved Knoll Textiles and Spinneybeck leathers may be ordered. Customer's Own Materials available pending approval. Please note that leathers and vinyls will experience slight puckering around the corners. This will not detract from the beauty and quality of the upholstery.	Upholstery seats are constructed of high-density foam, wrapped in textile or leather, with a plywood bottom for stability. Upholstery backs and arms are constructed of high-density foam molded over a steel frame.
<b>PL</b> Pixel Lounge			
<b>S</b> Seat			
<b>2</b> Straight			
<b>EBR</b> 90° Corner Seat with back, right arm			
<b>R</b> Right arms			
<b>K20265</b> Delite, Parrot	<b>Base Grade</b> Knoll Textiles Infinite K2263 is the base grade textile for Pixel Lounge. Please refer to Materials and Finishes page 5 for specification details.		
<b>ORA</b> Reveal color			

# Build-to-Spec - Upper Components - Seats

Pixel Lounge

*Leather*  
*by Marc Krusin*

description	w	d	h	pattern no.	COL U	V	W	X	Y
Straight 90° corner seat with back, right arm	32"	32"	20 1/2"	<b>PLS2EBR</b>	\$5,563.	\$6,525.	\$7,765.	\$8,111.	\$8,455.



Straight 90° corner seat with back, left arm	32"	32"	20 1/2"	<b>PLS2EBL</b>	5,563.	6,525.	7,765.	8,111.	8,455.
--	-----	-----	---------	----------------	--------	--------	--------	--------	--------



Straight seat with back, with high arms	32 3/4"	32"	20 1/2"	<b>PLS2LAH</b>	5,132.	5,853.	6,783.	7,044.	7,300.
---	---------	-----	---------	----------------	--------	--------	--------	--------	--------



Straight seat with back, with low arms	31 1/2"	32"	20 1/2"	<b>PLS2LAL</b>	5,611.	6,571.	7,812.	8,159.	8,502.
--	---------	-----	---------	----------------	--------	--------	--------	--------	--------



Order Code	Specification Information	Application Notes	Construction
<i>Example:</i> <b>PLS2EBR-AU0615</b>	<b>To order please specify</b>	<b>Upholstery / COM information:</b>	Upholstery seats are constructed of high-density foam, wrapped in textile or leather, with a plywood bottom for stability. Upholstery backs and arms are constructed of high-density foam molded over a steel frame.
<b>PL</b> Pixel Lounge	1. Pattern Number	Prices shown include fabric or leather upholstery. Contact your Knoll representative for colors.	
<b>S</b> Seat	2. Leather	Only approved Knoll Textile and Spinneybeck leathers may be ordered.	
<b>2</b> Straight	Note: Reveal option not available on leather or vinyl upholstery.	Customer's Own Materials available pending approval.	
<b>EBR</b> 90° Corner Seat with back		Please note that leathers and vinyls will experience slight puckering around the corners. This will not detract from the beauty and quality of the upholstery.	
<b>AU0615</b> Spinneybeck Acqua Red Sea			

# Build-to-Spec - Upper Components - Arms

Pixel Lounge

*Fabric*

*by Marc Krusin*

description	w	d	h	pattern no.	Base Grade	A	COM B	C	D	E	F	G	H	I
Intermediate arm	3"	22"	17 1/2"	<b>PLA6</b>	\$578.	\$584.	\$599.	\$613.	\$623.	\$632.	\$650.	\$658.	\$669.	\$707.



## Order Code

*Example:* **PLA6-K20265 - ORA**

<b>PL</b>	Pixel Lounge
<b>A</b>	Accessories
<b>6</b>	Intermediate arm
<b>K20265</b>	Delite, Parrot
<b>ORA</b>	Reveal Color

## Specification Information

### To order please specify:

1. Pattern Number
2. Textile
3. Reveal color

### Base Grade

Knoll Textiles Infinite K2263 is the base grade textile for Pixel Lounge. Please refer to Materials and Finishes page 5 for specification details.

## Application Notes

### Upholstery / COM information:

Prices shown include fabric or leather upholstery. Contact your Knoll representative for colors.

Only approved Knoll Textile and Spinneybeck leathers may be ordered.

Customer's Own Materials available pending approval.

## Construction

Upholstery arms are constructed of high-density foam molded over a steel frame.

# Build-to-Spec - Upper Components - Arms

Pixel Lounge

*Leather*

*by Marc Krusin*

description	w	d	h	pattern no.	COL U	V	W	X	Y
Intermediate arm	3"	22"	17 1/2"	<b>PLA6</b>	\$764.	\$836.	\$931.	\$958.	\$985.



Order Code	Specification Information	Application Notes	Construction
<i>Example:</i> <b>PLA6-AU0615</b>	<b>To order please specify:</b>	<b>Upholstery / COM information:</b>	Upholstery arms are constructed of high-density foam molded over a steel frame.
<b>PL</b> Pixel Lounge	1. Pattern Number	Prices shown include fabric or leather upholstery. Contact your Knoll representative for colors.	
<b>A</b> Accessories	2. Leather	Only approved Knoll Textile and Spinneybeck leathers may be ordered.	
<b>6</b> Intermediate arm		Customer's Own Materials available pending approval.	
<b>AU0615</b> Spinneybeck Acqua Red Sea			



## Low Tables

by Marc Krusin

description	w	d	h	pattern no.	list
Low Table	25 1/2"	25 1/2"	3/4"	<b>PLT2F</b>	\$333.



No cutouts

### Order Code

<i>Example:</i>	<b>PLT2F-Y</b>
<b>PL</b>	Pixel Lounge
<b>T</b>	Table
<b>2</b>	Low Tables, Straight
<b>F</b>	Flat
<b>118</b>	Bright White, matte
<b>118</b>	Bright White, matte
<b>Y</b>	No cutout

### Specification Information

#### To order please specify:

1. Pattern Number
2. Table top finish
3. Edgeband finish
4. Cutout option

For table top and edgeband finish, please refer to Materials and Finishes on page 5.

Electrical cutout: (\$30 list per cutout)  
 PLT2F Low tables may be specified with cutouts to accommodate an electrical module.  
 Place indicated code for cutout location after Low table pattern number.

Y = No cutouts



CC = Center-center



CS = Center-side.



# Build-to-Spec - Upper Components - Tables

## Upmounted Swivel Tables

### Pixel Lounge™

Pixel Lounge

description	w	d	h	pattern no.	list
Upmounted swivel table with dual USB-A power	18 <sup>3</sup> / <sub>4</sub> "	9"	15 <sup>1</sup> / <sub>2</sub> "	<b>PLT3SP</b>	\$1,050.



Upmounted swivel table without power	18 <sup>3</sup> / <sub>4</sub> "	9"	15 <sup>1</sup> / <sub>2</sub> "	<b>PLT3SN</b>	725.
--------------------------------------	----------------------------------	----	----------------------------------	---------------	------



Order Code	Specification Information	Description
<i>Example:</i> <b>PLT3SP</b>	<b>To order please specify:</b>	Powder coated aluminum, upmounted swivel table. Table swivels in left and right directions, 180 degrees. Available with Dual USB-A power or without power.
<b>PL</b> Pixel Lounge	1. Pattern Number	
<b>T</b> Table	2. Base finish	
<b>3</b> Upmounted	<i>Upright table finishes:</i>	
<b>S</b> Swivel	118T Bright White	
<b>P</b> Powered	114T Folkstone Grey	
<b>118T</b> Bright White	111T Jet Black	
	134T Knoll Red	

# Build-to-Spec - Lower Components - Electrical

## *Electrical Modules for Low Tables*

by Marc Krusin

description	type	w	d	pattern no.	list
Electrical module for low tables 3 receptacle, 3 power, cordset	48" cordset	6.11"	4.51"	<b>PLED3AC48</b>	\$614.
	72" cordset	6.11"	4.51"	<b>PLED3AC72</b>	614.

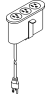

Electrical module for low tables 3 receptacle, 3 power, hardwired	72" hardwire	6.11"	4.51"	<b>PLED3AH72</b>	723.
--	--------------	-------	-------	------------------	------



Electrical module for low tables 3 receptacle, 2 power 1 dual USB-A, cordset	48" cordset	6.11"	4.51"	<b>PLED3BC48</b>	797.
	72" cordset	6.11"	4.51"	<b>PLED3BC72</b>	797.



Electrical module for low tables 3 receptacle, 2 power 1 dual USB-A, hardwire	72" hardwire	6.11"	4.51"	<b>PLED3BH72</b>	908.
--	--------------	-------	-------	------------------	------



Order Code	Specification Information	Finish Options	Pixel trade
<i>Example:</i> <b>PLED3AC48-BK</b>	<b>To order please specify:</b>	<b>Case and Receptacle Finishes</b>	<b>Under the Seat Power Modules:</b>
<b>PL</b> Pixel Lounge	1. Pattern Number	Black case with black receptacles (suffix <b>BK</b> )	The power modules located under the seat are able to be plugged into the Pixel Trac system, once in place.
<b>E</b> Electrical	2. Module Color finish	White case with white receptacles (suffix <b>WH</b> )	There are two versions of the power modules: a 2-receptacle model and a 3-receptacle model. Each model offers two electrical configurations and is available cordset or hardwired. The power modules are UL 962A certified and TAA compliant.
<b>D</b> Low Tables			
<b>3</b> Three receptacle module			
<b>A</b> 3 power			
<b>C48</b> 48" cordset			
<b>BK</b> Black case with black receptacle			

Build-to-Spec - Lower Components - Electrical  
*Electrical Modules for Low Tables*  
 by Marc Krusin

description	type	w	d	pattern no.	list
Cord manager clip				<b>KE-KLH</b>	\$74.



Order Code	Specification Information	Finish Options	Pixel trade
<i>Example:</i> <b>PLED3AC48-BK</b>	<b>To order please specify:</b>	<b>Case and Receptacle Finishes</b>	<b>Under the Seat Power Modules:</b>
<b>PL</b> Pixel Lounge	1. Pattern Number	Black case with black receptacles (suffix <b>BK</b> )	The power modules located under the seat are able to be plugged into the Pixel Trac system, once in place.
<b>E</b> Electrical	2. Module Color finish	White case with white receptacles (suffix <b>WH</b> )	There are two versions of the power modules: a 2-receptacle model and a 3-receptacle model. Each model offers two electrical configurations and is available cordset or hardwired. The power modules are UL 962A certified and TAA compliant.
<b>D</b> Low Tables			
<b>3</b> Three receptacle module			
<b>A</b> 3 power			
<b>C48</b> 48" cordset			
<b>BK</b> Black case with black receptacle			

# Build-to-Spec - Lower Components - Electrical

## *Electrical Modules for Under the Seat*

by Marc Krusin

description	type	w	d	pattern no.	list
Electrical module for under the seat 2 receptacle, 1 power, 1 Dual USB-A, cordset	72" cordset	5.50"	8.71"	<b>PLEU2BC72</b>	\$438.

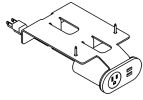

Electrical module for under the seat 2 receptacle, 1 Dual USB-A, 1 USB-C, cordset	72" cordset	5.50"	8.71"	<b>PLEU2CC72</b>	567.
--	-------------	-------	-------	------------------	------

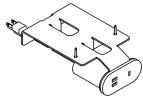

Electrical module for under the seat 2 receptacle, 1 power, 1 Dual USB-A, hardwire	72" hardwire	5.50"	8.71"	<b>PLEU2BH72</b>	515.
---	--------------	-------	-------	------------------	------

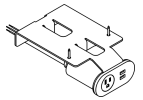

Electrical module for under the seat 2 receptacle, 1 Dual USB-A, 1 USB-C, hardwire	72" hardwire	5.50"	8.71"	<b>PLEU2CH72</b>	644.
---	--------------	-------	-------	------------------	------

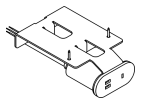

Order Code	Specification Information	Finish Options	Pixel trade
<i>Example:</i> <b>PLEU2BC72-111T</b>	<b>To order please specify:</b>	<i>Power Module Color:</i>	<b>Under the Seat Power Modules:</b>
<b>PL</b> Pixel Lounge	1. Pattern Number	<b>Color</b> <b>Code</b>	The power modules located under the seat are able to be plugged into the Pixel Trac system, once in place.
<b>E</b> Electrical	2. Module Color finish	<b>Black</b> <b>111T</b>	There are two versions of the power modules: a 2-receptacle model and a 3-receptacle model. Each model offers two electrical configurations and is available cordset or hardwired. The power modules are UL 962A certified and TAA compliant.
<b>U</b> Electrical Undermount		<b>White</b> <b>118T</b>	
<b>2B</b> 2 receptacle, 1 power, 1 dual USB-A		<b>Folkstone Grey</b> <b>114T</b>	
<b>C</b> Cordset		<b>Red</b> <b>134T</b>	
<b>72</b> 72" Length			
<b>111T</b> Black module color			

# Build-to-Spec - Lower Components - Electrical

## *Electrical Modules for Under the Seat*

by Marc Krusin

description	type	w	d	pattern no.	list
Electrical module for under the seat 3 receptacle, 2 power, 1 Dual USB-A, cordset	72" cordset	5.50"	8.71"	<b>PLEU3BC72</b>	\$515.

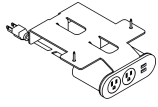

Electrical module for under the seat 3 receptacle, 1 power, 1 Dual USB-A, 1 USB-C, cordset	72" cordset	5.50"	8.71"	<b>PLEU3CC72</b>	593.
--	-------------	-------	-------	------------------	------

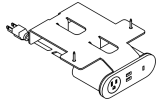

Electrical module for under the seat 3 receptacle, 2 power, 1 Dual USB-A, hardwire	72" hardwire	5.50"	8.71"	<b>PLEU3BH72</b>	593.
---	--------------	-------	-------	------------------	------

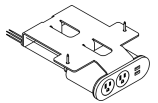

Electrical module for under the seat 3 receptacle, 1 power, 1 Dual USB-A, 1 USB-C, hardwire	72" hardwire	5.50"	8.71"	<b>PLEU3CH72</b>	670.
---	--------------	-------	-------	------------------	------

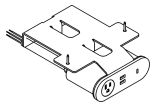

Order Code	Specification Information	Finish Options	Pixel trade
<i>Example:</i> <b>PLEU2BC72-111T</b>	<b>To order please specify:</b>	<i>Power Module Color:</i>	<b>Under the Seat Power Modules:</b>
<b>PL</b> Pixel Lounge	1. Pattern Number	<b>Color</b> <b>Code</b>	The power modules located under the seat are able to be plugged into the Pixel Trac system, once in place.
<b>E</b> Electrical	2. Module Color finish	<b>Black</b> <b>111T</b>	There are two versions of the power modules: a 2-receptacle model and a 3-receptacle model. Each model offers two electrical configurations and is available cordset or hardwired. The power modules are UL 962A certified and TAA compliant.
<b>U</b> Electrical Undermount		<b>White</b> <b>118T</b>	
<b>2B</b> 2 receptacle, 1 power, 1 dual USB-A		<b>Folkstone Grey</b> <b>114T</b>	
<b>C</b> Cordset		<b>Red</b> <b>134T</b>	
<b>72</b> 72" Length			
<b>111T</b> Black module color			

# Build-to-Spec - Lower Components - Beams

Pixel Lounge

## *Straight Beams, Standard*

*by Marc Krusin*

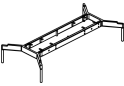
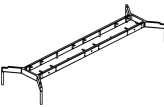
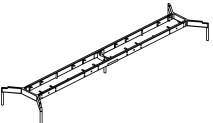
description	w	d	h	pattern no.	list
Straight, Standard, 1-seat 	24 1/2"	24 1/2"	9"	<b>PLB2S1</b>	\$846.
Straight, Standard, 2-seat 	50 1/2"	24 1/2"	9"	<b>PLB2S2</b>	1,028.
Straight, Standard, 3-seat 	76 3/4"	24 1/2"	9"	<b>PLB2S3</b>	1,190.
Straight, Standard, 4-seat 	102 3/4"	24 1/2"	9"	<b>PLB2S4</b>	1,523.

### Order Code

<i>Example:</i>	<b>PLB2S1-AP</b>
<b>PL</b>	Pixel Lounge
<b>B</b>	Beam
<b>2</b>	Straight
<b>S</b>	Standard
<b>1</b>	1-seat
<b>AP</b>	Polished Aluminum Leg

### Specification Information

#### To order please specify:

1. Pattern Number
2. Leg finish

#### End and Intermediate Leg Finish:

**AP** = Polished Aluminum

**111T** = Jet Black

**118T** = Bright White

Beam rails are only available in Jet Black 111T.

Mid-span leg is only available in Jet Black 111T.

### Description and Construction

Standard Beams may be specified on their own to support seats and tables or may be utilized as a foundational starting point from which to further build on a seating configuration. They allow for planning straight runs in lengths up to 4 seat or table positions.

Beam components are constructed of steel tubing and are shipped knocked-down, to be assembled on-site with included hardware.

# Build-to-Spec - Lower Components - Beams

Pixel Lounge

## Straight Beams, Return

by Marc Krusin

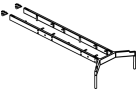
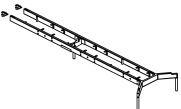
description	w	d	h	pattern no.	list
Straight, Return, 1-seat 	33 1/2"	24 1/2"	9"	<b>PLB2R1</b>	\$666.
Straight, Return, 2-seat 	59 3/4"	24 1/2"	9"	<b>PLB2R2</b>	822.
Straight, Return, 3-seat 	85 3/4"	24 1/2"	9"	<b>PLB2R3</b>	1,221.

Order Code	Specification Information	Description and Construction
<i>Example:</i> <b>PLB2R1-AP</b>	<b>To order please specify:</b>	Pixel Lounge Returns provide planning opportunities as a base structure that extends perpendicularly from another beam to create an "L" or "T" shape configuration. They allow for planning returns of up-to three seat or table positions.
<b>PL</b> Pixel Lounge	1. Pattern Number	
<b>B</b> Beam	2. Leg finish	Beam components are constructed of steel tubing and are shipped knocked-down, to be assembled on-site with included hardware.
<b>2</b> Straight	End and Intermediate Leg Finish:	
<b>R</b> Return	<b>AP</b> = Polished Aluminum	
<b>1</b> 1-seat	<b>111T</b> = Jet Black	
<b>AP</b> Polished Aluminum Leg	<b>118T</b> - Bright White	
	Beam rails are only available in Jet Black 111T.	
	Mid-span leg is only available in Jet Black 111T.	



# Build-to-Spec - Lower Components - Beams

## *Straight Beams, Intermediate Return*

by Marc Krusin

Pixel Lounge

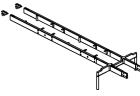
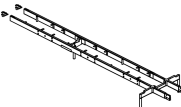
description	w	d	h	pattern no.	list
Straight, Intermediate Return, 1-seat 	45"	24 1/2"	9"	<b>PLB2M1</b>	\$880.
Straight, Intermediate Return, 2-seat 	71 1/4"	24 1/2"	9"	<b>PLB2M2</b>	1,036.
Straight, Intermediate Return, 3-seat 	97 1/4"	24 1/2"	9"	<b>PLB2M3</b>	1,435.



Order Code	Specification Information	Description and Construction
<i>Example:</i> <b>PLB2M1-AP</b>	<b>To order please specify:</b>	Intermediate Returns allow for planning returns in lengths greater than 3 seat positions. Intermediate returns connect perpendicularly to a base structure in an identical manner to that of a return beam.
<b>PL</b> Pixel Lounge	1. Pattern Number	
<b>B</b> Beam	2. Leg finish	Beam components are constructed of steel tubing and are shipped knocked-down, to be assembled on-site with included hardware.
<b>2</b> Straight	End and Intermediate Leg Finish:	
<b>M</b> Intermediate Return	<b>AP</b> = Polished Aluminum	
<b>1</b> 1-seat	<b>111T</b> = Jet Black	
<b>AP</b> Polished Aluminum Leg	<b>118T</b> - Bright White	
	Beam rails are only available in Jet Black 111T.	
	Mid-span leg is only available in Jet Black 111T.	

# Build-to-Spec - Lower Components - Beams

Pixel Lounge

## *Straight Beams, Starter*

*by Marc Krusin*

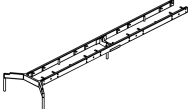
description	w	d	h	pattern no.	list
Straight, Starter, 1-seat 	17 1/2"	24 1/2"	9"	<b>PLB2A1</b>	\$497.
Straight, Starter, 2-seat 	43 3/4"	24 1/2"	9"	<b>PLB2A2</b>	677.
Straight, Starter, 3-seat 	69 3/4"	24 1/2"	9"	<b>PLB2A3</b>	839.
Straight, Starter, 4-seat 	95 3/4"	24 1/2"	9"	<b>PLB2A4</b>	1,173.

Order Code	Specification Information	Description and Construction
<i>Example:</i> <b>PLB2A1-AP</b>	<b>To order please specify:</b>	Pixel Lounge Starter Beams are the foundational planning module when planning straight beam configurations longer than 4-seat or table positions.
<b>PL</b> Pixel Lounge	1. Pattern Number	
<b>B</b> Beam	2. Leg finish	Beam components are constructed of steel tubing and are shipped knocked-down, to be assembled on-site with included hardware.
<b>2</b> Straight	End and Intermediate Leg Finish:	
<b>A</b> Starter	<b>AP</b> = Polished Aluminum	
<b>1</b> 1-seat	<b>111T</b> = Jet Black	
<b>AP</b> Polished Aluminum Leg	<b>118T</b> - Bright White	
	Beam rails are only available in Jet Black 111T.	
	Mid-span leg is only available in Jet Black 111T.	

# Build-to-Spec - Lower Components - Beams

Pixel Lounge

## Straight Beams, Extension

by Marc Krusin

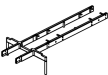
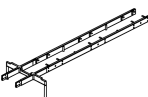
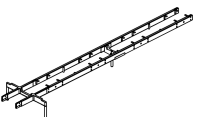
description	w	d	h	pattern no.	list
Straight, Extension, 1-seat 	10 <sup>3</sup> / <sub>4</sub> "	9 <sup>1</sup> / <sub>2</sub> "	2 <sup>1</sup> / <sub>2</sub> "	<b>PLB2E1</b>	\$711.
Straight, Extension, 2-seat 	36 <sup>3</sup> / <sub>4</sub> "	9 <sup>1</sup> / <sub>2</sub> "	2 <sup>1</sup> / <sub>2</sub> "	<b>PLB2E2</b>	892.
Straight, Extension, 3-seat 	63"	9 <sup>1</sup> / <sub>2</sub> "	2 <sup>1</sup> / <sub>2</sub> "	<b>PLB2E3</b>	1,053.
Straight, Extension, 4-seat 	89"	9 <sup>1</sup> / <sub>2</sub> "	2 <sup>1</sup> / <sub>2</sub> "	<b>PLB2E4</b>	1,388.

### Order Code

<i>Example:</i>	<b>PLB2E1-AP</b>
<b>PL</b>	Pixel Lounge
<b>B</b>	Beam
<b>2</b>	Straight
<b>E</b>	Extension
<b>1</b>	1-seat
<b>AP</b>	Polished Aluminum Leg

### Specification Information

#### To order please specify:

1. Pattern Number
2. Leg finish

#### End and Intermediate Leg Finish:

**AP** = Polished Aluminum

**111T** = Jet Black

**118T** = Bright White

Beam rails are only available in Jet Black 111T.  
Mid-span leg is only available in Jet Black 111T.





### Description and Construction

Extension beams allow for planning straight runs in lengths greater than 4 seat positions.

Beam components are constructed of steel tubing and are shipped knocked-down, to be assembled on-site with included hardware.

## Straight Beams, Connector

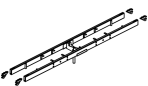
by Marc Krusin

description	w	d	h	pattern no.	list
Straight, Connector, No seat 	16 <sup>3</sup> / <sub>4</sub> "	9 <sup>1</sup> / <sub>2</sub> "	2 <sup>1</sup> / <sub>2</sub> "	<b>PLB2CN</b>	\$305.
Straight, Connector, 1-seat 	42 <sup>3</sup> / <sub>4</sub> "	9 <sup>1</sup> / <sub>2</sub> "	2 <sup>1</sup> / <sub>2</sub> "	<b>PLB2C1</b>	511.
Straight, Connector, 2-seat 	68 <sup>3</sup> / <sub>4</sub> "	9 <sup>1</sup> / <sub>2</sub> "	2 <sup>1</sup> / <sub>2</sub> "	<b>PLB2C2</b>	909.
Straight, Back to Back Connector 	29 <sup>1</sup> / <sub>2</sub> "	9 <sup>1</sup> / <sub>2</sub> "	2 <sup>1</sup> / <sub>2</sub> "	<b>PLB2CBN</b>	367.



Order Code	Specification Information	Description and Construction
<i>Example:</i> <b>PLB2C1-AP</b>	<b>To order please specify:</b>	Connectors connect perpendicularly to two parallel base structures.
<b>PL</b> Pixel Lounge	1. Pattern Number	Beam components are constructed of steel tubing and are shipped knocked-down, to be assembled on-site with included hardware.
<b>B</b> Beam	2. Leg finish	
<b>2</b> Straight	End and Intermediate Leg Finish:	
<b>C</b> Connector	<b>AP</b> = Polished Aluminum	
<b>1</b> 1-seat	<b>111T</b> = Jet Black	
<b>AP</b> Polished Aluminum Leg	<b>118T</b> - Bright White	
	Beam rails are only available in Jet Black 111T.	
	Mid-span leg is only available in Jet Black 111T.	

# Build-to-Spec - Lower Components - Legs

Pixel Lounge

## Legs

by *Marc Krusin*

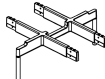
description	w	d	h	pattern no.	list
End Leg 	10"	24 1/2"	9"	<b>PLLE</b>	\$351.
Mid-span Leg 	6"	10"	8 3/4"	<b>PLLM</b>	568.
Intermediate Leg 	19 1/2"	24 1/2"	9"	<b>PLLI</b>	566.

### Order Code

*Example:* **PLLI-AP**

<b>PL</b>	Pixel Lounge
<b>I</b>	Intermediate
<b>AP</b>	Polished Aluminum Leg

### Specification Information

#### To order please specify:

1. Pattern Number
  2. Leg finish
- Leg finish color (End and Intermediate Leg Finish):  
**AP** = Polished Aluminum  
**111T** = Jet Black  
**118T** = Bright White



Mid-span leg is only available in Jet Black 111T.

Note: End Leg and Mid-span Leg are available for replacement purposes.  
 Pixel Lounge Standard Beams come with two End Legs.  
 Mid-Span Legs are included with several Beam components to give additional support to long beam lengths.

# Build-to-Spec - Electrical

## *Pixel™ Trac*

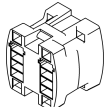
by Marc Krusin

description	type	pattern no.	list
Receptacle to Receptacle Connector 		<b>PLKTR</b>	\$27.
H - Connector 		<b>PLKTH</b>	32.
Duplex Kit 	Circuit 1	<b>PLKTD</b>	109.
	Circuit 2	<b>PLKTD2</b>	98.

Order Code	Specification Information	Pixel trade	Ordering Information
<i>Example:</i> <b>PLKTSH72</b>	<b>To order please specify:</b> 1. Pattern Number 2. Conduit length	<b>Pixel™ Trac</b> is a non-sequential modular power system that allows users to link up to 13 duplex receptacles together off of one hardwired power infeed. With locking and keyed connectors, installation is a snap. Pixel Trac is a UL Listed Manufactured Wiring System.  <b>Pixel™ Trac Starter:</b> Pixel™ Trac Starter cables (PLKTSH/SC) are metal clad and connect to the power source. They have a locking and keyed connector on the opposite end that snaps into a Pixel Trac Duplex (PLKTD).  <b>Pixel™ Trac Kit:</b> Pixel Trac Kits are offered in a variety of lengths to best fit your lounge configuration. Each kit includes a metal clad jumper with a duplex attached. Choose a Trac Kit (PLKTK) that matches the length between duplex receptacles (PLKTD) placed on the beam structure.	Each starter (infeed) cable can accommodate a maximum of (13) Pixel Trac jumper kits. Choose the length of the Starter Kit (PLKTSH/SC) that corresponds to the distance to your power source.  Select the Pixel Trac Kit (PLKTK) that is the same length as the distance between where you have chosen to place the duplex receptacles (PLKTD).
<b>PL</b> Pixel Lounge			
<b>KTSH</b> Starter cable, hardwire			
<b>72</b> 72" metal conduit			

# Build-to-Spec - Electrical

## Pixel™ Trac

by Marc Krusin

description	power cord length	pattern no.	list
Starter Cable, Hardwire, Circuit 1, 2	120" Cable for Hardwire	<b>PLKTSH120</b>	\$191.
	72" Cable for Hardwire	<b>PLKTSH72</b>	153.

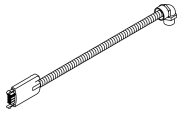

Starter Cable, Cordset, 20 AMP, Circuit 1, 2	120" Cable for Cordset	<b>PLKTSC120</b>	327.
	72" Cable for Cordset	<b>PLKTSC72</b>	284.



Order Code	Specification Information	Pixel trade	Ordering Information
<i>Example:</i> <b>PLKTSH72</b>	<b>To order please specify:</b> 1. Pattern Number 2. Conduit length	<b>Pixel™ Trac</b> is a non-sequential modular power system that allows users to link up to 13 duplex receptacles together off of one hardwired power infeed. With locking and keyed connectors, installation is a snap. Pixel Trac is a UL Listed Manufactured Wiring System.  <b>Pixel™ Trac Starter:</b> Pixel™ Trac Starter cables (PLKTSH/SC) are metal clad and connect to the power source. They have a locking and keyed connector on the opposite end that snaps into a Pixel Trac Duplex (PLKTD).  <b>Pixel™ Trac Kit:</b> Pixel Trac Kits are offered in a variety of lengths to best fit your lounge configuration. Each kit includes a metal clad jumper with a duplex attached. Choose a Trac Kit (PLKTK) that matches the length between duplex receptacles (PLKTD) placed on the beam structure.	Each starter (infeed) cable can accommodate a maximum of (13) Pixel Trac jumper kits. Choose the length of the Starter Kit (PLKTSH/SC) that corresponds to the distance to your power source.  Select the Pixel Trac Kit (PLKTK) that is the same length as the distance between where you have chosen to place the duplex receptacles (PLKTD).
<b>PL</b> Pixel Lounge			
<b>KTSH</b> Starter cable, hardwire			
<b>72</b> 72" metal conduit			

# Build-to-Spec - Electrical

## Pixel™ Trac

by Marc Krusin

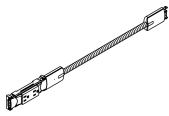
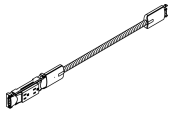
description	power cord length	pattern no.	list
 Single Duplex Kit, Circuit 1	24" metal conduit	<b>PLKTK24</b>	\$196.
	36" metal conduit	<b>PLKTK36</b>	207.
	48" metal conduit	<b>PLKTK48</b>	234.
	60" metal conduit	<b>PLKTK60</b>	245.
	72" metal conduit	<b>PLKTK72</b>	262.
	84" metal conduit	<b>PLKTK84</b>	273.
	96" metal conduit	<b>PLKTK96</b>	289.
 Single Duplex Kit, Circuit 2	24" metal conduit	<b>PLKTK242</b>	196.
	36" metal conduit	<b>PLKTK362</b>	207.
	48" metal conduit	<b>PLKTK482</b>	218.
	60" metal conduit	<b>PLKTK602</b>	229.
	72" metal conduit	<b>PLKTK722</b>	240.
	84" metal conduit	<b>PLKTK842</b>	250.
	96" metal conduit	<b>PLKTK962</b>	262.

Order Code	Specification Information	Pixel trade	Ordering Information
<i>Example:</i> <b>PLKTSH72</b>	<b>To order please specify:</b> 1. Pattern Number 2. Conduit length	<b>Pixel™ Trac</b> is a non-sequential modular power system that allows users to link up to 13 duplex receptacles together off of one hardwired power infeed. With locking and keyed connectors, installation is a snap. Pixel Trac is a UL Listed Manufactured Wiring System.  <b>Pixel™ Trac Starter:</b> Pixel™ Trac Starter cables (PLKTSH/SC) are metal clad and connect to the power source. They have a locking and keyed connector on the opposite end that snaps into a Pixel Trac Duplex (PLKTD).  <b>Pixel™ Trac Kit:</b> Pixel Trac Kits are offered in a variety of lengths to best fit your lounge configuration. Each kit includes a metal clad jumper with a duplex attached. Choose a Trac Kit (PLKTK) that matches the length between duplex receptacles (PLKTD) placed on the beam structure.	Each starter (infeed) cable can accommodate a maximum of (13) Pixel Trac jumper kits. Choose the length of the Starter Kit (PLKTSH/SC) that corresponds to the distance to your power source.  Select the Pixel Trac Kit (PLKTK) that is the same length as the distance between where you have chosen to place the duplex receptacles (PLKTD).
<b>PL</b> Pixel Lounge			
<b>KTSH</b> Starter cable, hardwire			
<b>72</b> 72" metal conduit			



<i>pattern no.</i>	<i>page</i>	<i>pattern no.</i>	<i>page</i>
KE-KLH	35	PLK9	13, 15
PLA6	30, 31	PLKTD	45
PLB2A1	41	PLKTD2	45
PLB2A2	41	PLKTH	45
PLB2A3	41	PLKTK24	47
PLB2A4	41	PLKTK242	47
PLB2C1	43	PLKTK36	47
PLB2C2	43	PLKTK362	47
PLB2CBN	43	PLKTK48	47
PLB2CN	43	PLKTK482	47
PLB2E1	42	PLKTK60	47
PLB2E2	42	PLKTK602	47
PLB2E3	42	PLKTK72	47
PLB2E4	42	PLKTK722	47
PLB2M1	40	PLKTK84	47
PLB2M2	40	PLKTK842	47
PLB2M3	40	PLKTK96	47
PLB2R1	39	PLKTK962	47
PLB2R2	39	PLKTR	45
PLB2R3	39	PLKTSC120	46
PLB2S1	38	PLKTSC72	46
PLB2S2	38	PLKTSH120	46
PLB2S3	38	PLKTSH72	46
PLB2S4	38	PLLE	44
PLED3AC48	34	PLLI	44
PLED3AC72	34	PLLM	44
PLED3AH72	34	PLS2BALH	26, 27
PLED3BC48	34	PLS2BALL	26, 27
PLED3BC72	34	PLS2BARH	26, 27
PLED3BH72	34	PLS2BARL	26, 27
PLEU2BC72	36	PLS2BC	24, 25
PLEU2BH72	36	PLS2EBL	28, 29
PLEU2CC72	36	PLS2EBR	28, 29
PLEU2CH72	36	PLS2LAH	28, 29
PLEU3BC72	37	PLS2LAL	28, 29
PLEU3BH72	37	PLS2NAL	24, 25
PLEU3CC72	37	PLS2NAR	24, 25
PLEU3CH72	37	PLS2NC	24, 25
PLK1	11, 12	PLT2F	32
PLK10	14, 15	PLT3SN	33
PLK11	16, 17	PLT3SP	33
PLK12	16, 17		
PLK13	16, 17		
PLK14	18, 19		
PLK15	18, 19		
PLK16	18, 19		
PLK17	18, 19		
PLK18	20, 21		
PLK19	20, 21		
PLK2	11, 12		
PLK20	20, 21		
PLK21	22, 23		
PLK22	22, 23		
PLK3	11, 12		
PLK4	11, 12		
PLK5	11, 12		
PLK6	13, 15		
PLK7	13, 15		
PLK8	13, 15		

# Selling Policy

This Selling Policy supersedes all previous selling policies and is inclusive of Knoll, KnollStudio and Muuto. Prices, discounts and product offerings are subject to change without notice.

<b>Terms &amp; Conditions of Sales</b>	Sales by Knoll, Inc. or Knoll North America Corp. ("Seller") of Knoll Product Lines (hereinafter "Products") within the United States and Canada are made only on the terms which are contained in this Selling Policy. Seller hereby gives notice of its objection to any different or additional terms and conditions. This sale is expressly conditional upon Purchaser's assent to the terms and conditions set forth below. Additional terms and conditions may apply to KnollStudio and KnollTextiles orders. These terms and conditions may be modified or supplemented only by a written document signed by an authorized representative of Seller. These terms and conditions supersede any prior and/or contemporaneous agreements or correspondence between Purchaser and Seller. Written quotations expire thirty (30) days from the date of issuance and can be withdrawn by written notice anytime during that period. Where Purchaser and Seller have entered into the Knoll Electronic Terms and Conditions, all orders, acknowledgements, invoices and other business communications placed or transmitted in accordance with the Knoll Electronic Terms and Conditions shall be deemed to be in writing and signed and shall be valid for all purposes as if they were originated and maintained in documentary form.
<b>Ordering Information</b>	All orders must be in writing. The product pattern number(s) contained on Seller's order acknowledgement shall be the final expression of the order.
<b>Order Confirmation</b>	A purchase order is not binding on Seller until Purchaser has received Seller's order confirmation or acknowledgment.
<b>Pricing Policies</b>	List prices are subject to change without notice. List prices shall be those prices in effect on the date of receipt of a complete purchase order unless shipment is requested more than ninety (90) days after order entry in which case prices in effect on the date of shipment apply. List prices include specified freight costs. Unless specified in writing by Seller, no other charges are included in Seller's list prices.
<b>Taxes</b>	All sales, use, excise and other taxes applicable to the sale of the Products shall be paid by Purchaser. If Purchaser claims an exemption from any tax, Purchaser shall submit to Seller the appropriate exemption certificates.
<b>Terms of Payment</b>	Payment for one hundred percent (100%) of the net order amount (including any applicable shipping and handling fee) is due within thirty (30) days of the date of invoice, which is generally issued upon shipment. In case of any discrepancies, such as shortages, and Seller is notified in writing within ten (10) days of receipt of Product, only that portion may be deducted and the balance paid. For orders greater than \$100,000 net, a fifty percent (50%) deposit is due at the time of order placement, with the remainder due within thirty (30) days of the date of invoice. KnollStudio orders less than \$2,000 require payment for one hundred percent (100%) of the net order amount (including any applicable sales tax and charges for inside delivery, special packaging, etc.), due at time of order placement. For KnollStudio orders greater than \$2,000, a one-half (50%) deposit is due at time of order placement with the remainder (including any applicable sales tax and charges for inside delivery, special packaging, etc.) due prior to shipment. If, in the judgment of Seller, Purchaser's financial condition does not justify the terms of the payment, Seller may require full or partial payment in advance. Past due accounts shall be charged one and one-half percent (1.5%) per month, or the highest rate permitted by law, whichever is less, and will be added to the outstanding balance. In the event Purchaser defaults on payment, Purchaser shall be liable for all collection costs, including reasonable attorney's fees and costs.
<b>Changes and Cancellation</b>	Standard purchase orders may not be changed or cancelled, in whole or in part, without prior written consent of Seller. Changes may effect delivery dates. Expenses incurred because of changes shall be charged to Purchaser. In the event of cancellations, Purchaser will be liable for reasonable cancellation charges established by Seller. Orders for special Product, orders including "COM" (hereinafter defined) material and orders pursuant to expedited delivery programs, may not be canceled. QuickShip orders may not be changed or canceled without Knoll's authorization. In the event of Muuto order changes, 25% payment of original net order amount is required for changes incurring the week the order was entered. 100% payment of original net order amount is required for changes incurring the week the order is scheduled to ship. If Muuto is ordered on QuickShip, the QuickShip policy supersedes.
<b>Freight Prepaid</b>	For standard orders, freight is prepaid and included in the price of all Knoll Office and KnollStudio Products, except KnollTextiles and Muuto, within the 48 contiguous United States for orders placed with Knoll, Inc. and within Canada, excluding the Yukon, Northwest Territories, Nunavut and Newfoundland for orders placed with Knoll North America Corp. Packing is tested for rigorous motion and transportation but is not guaranteed to protect furniture from all conditions. If special packaging is required for any reason, please consult with your sales representative or dealer. Seller shall select the method of shipment and routing. Freight for all KnollTextiles orders is prepaid and added to the invoice. Freight for all Muuto orders must be specified at time of order placement and added to the PO.
<b>Delivery/Freight Charges</b>	Shipments outside the contiguous 48 United States and Canada shall be shipped F.O.B. Origin. For shipments outside the contiguous United States and Canada, Purchaser is responsible for the cost of freight from point of embarkation, including any handling and transportation charges incidental to loading at the point of departure and unloading at the final destination. Conditions beyond the control of Seller, including weather, available facilities and traffic conditions, may affect exact time of delivery. Seller shall not be responsible for specific carrier delivery date or time unless it has made a specific delivery commitment, in writing. Nonstandard methods of shipment and/or additional services are available upon request. Orders for QuickShip product shipping direct parcel or White Glove are subject to additional shipping and handling charges and must be paid by Purchaser. Purchaser will be billed for the differential cost of any special services in excess of standard surface carrier freight costs. Premium charges, at Purchaser's request, will be added for airfreight, exclusive use of vehicle and extra, export or special packaging. Accessorial charges will be added for inside delivery, extra labor, reassignment and redelivery. Partial shipments may be made and invoiced by Seller.
<b>Claims</b>	All shipments for Knoll Products within the contiguous United States and Canada are F.O.B. Origin. All risk of loss passes to Purchaser at time of delivery to carrier. Purchaser shall inspect all Products upon receipt and notify Seller within ten (10) working days after receipt of any damage or defects which are, or should be, apparent from an inspection of the Product and its packaging. Failure of Purchaser to notify Seller during the ten (10) working day period shall constitute acceptance of the Products and waiver of any apparent defects, errors or shortages. For all claims relating to Product damaged in transit or for any other claims relating to or arising out of the transportation of the Product, Purchaser must seek recovery from the carrier and Seller has no liability to Purchaser for such claims. Seller may, upon request, assist Purchaser with filing of such claims with the carrier, but Seller will not be liable for any of these transportation related claims.

# Selling Policy

---

<b>Seller's Security Interest</b>	Until Seller receives the full payment for the Product, Seller shall have a security interest in the Product. Purchaser agrees to perform all acts, including but not limited to the execution and filing of documentation, which may be necessary to perfect and assure the security interest of Seller.
<b>Returns</b>	The return of Products without a written authorization by Seller shall not be accepted. To receive authorization for Product return, please call Customer Service. All Products that are returned pursuant to a valid authorization shall be subject to a twenty-five percent (25%) of list restocking charge. Products not currently offered for sale by Seller (including COM) shall not be authorized for return. All returned Products must be unused, in original condition and in the original Seller packing cartons. No refund or credit shall be given for damaged Products.
<b>Held Orders/Storage</b>	If Purchaser requests that an order be held or delayed, prices and terms and conditions in effect at the time of shipment shall apply. If Purchaser requests a delay after the time when Seller can defer production, Purchaser will be invoiced for the Product, payable in accordance with standard terms, when the order is ready for shipment. Seller may transfer the Product to storage, in which case all expenses incurred in connection with storage, including demurrage, preparation for storage, storage charges and handling shall be payable by Purchaser upon submission of invoices by Seller. Risk of loss to the Product shall pass to the Purchaser upon delivery of the Product into storage.
<b>Customer's Own Material</b>	A Purchaser who requests a fabric or other surface material not standard to Seller's line of Products ("COM") must submit samples of the requested material to Seller prior to entry of a purchaser order. Seller shall determine if the material is suitable to its manufacturing processes and meets any requirements of Underwriters Laboratories. If the COM is acceptable, Seller will then establish a price for using the COM or the Product in question. For a description of the procedures for submitting samples and testing, contact customer resources or your sales representative. Seller shall have no responsibility for the appearance, condition, performance, durability, colorfastness or any other physical attribute of the COM. Purchaser shall indemnify and hold Seller harmless for any damages, injuries or losses arising out of or related to use of the COM on the Product.
<b>Warranty</b>	Seller warrants to the original Purchaser only that the Products Seller manufactures and sells to Purchaser are free of defects in workmanship and materials, during the applicable warranty period set forth below. Warranty period set forth below is for 24-hour, 7 days a week, multi shift use (includes parts and labor to repair). Should any failure to conform with this limited warranty appear to a Product listed below during the applicable warranty period from the date of shipment, Seller shall, upon prompt written notice, repair or replace, at its option and costs, the affected part or parts.

## Product and Period of Warranty

Lifetime: *Antenna Workspaces, AutoStrada, Calibre, Crinion Open Table, Currents, Dividends Horizon, Morrison, Reff Profiles* laminate, *Rockwell Unscripted, Series 2 Storage, Template, Quoin* and other non-wood components (except cascade edge worksurfaces, operational parts, controls, electrical, Lighting, *Series 2 Veneer Front Storage, digital locks, upholstery, textiles and leathers, special or custom products, see below), Islands Collection* table structure, legs, and laminate worksurfaces; and *Wexby* mobile bin.

12 Years: *Chadwick, Generation by Knoll, k. task, Life, Newson Task, Moment, MultiGeneration by Knoll, Ollo, ReGeneration by Knoll, Remix, and Toboggan* seating (except seating upholstery, textiles, leathers and finishes, see below).

10 Years: *Anchor Storage* except digital locks, *Antenna Workspaces, AutoStrada, Crinion Open Table, Dividends Horizon, Dividends Horizon Satellite Surfaces, Reff Profiles, Rockwell Unscripted, Quoin* wood components, *Template* wood components, *Series 2 Veneer Front Storage, cascade edge worksurfaces, Wood Casegoods* (The Graham Collection) (except wood casegoods upholstered surfaces, see below), *Reuter* overheads, *Reuter* vertical storage, *KnollExtra Sapper Monitor Arm Collection, Sapper XYZ Monitor Arm Series, Adjustable keyboard mechanisms and platforms, Communication Boards* (except fabric board textiles, cork and FilzFelt, see below), *Smokador* collection (except leathers, see below), *Orchestra Universal Systems Accessories, k. lounge* structural components, *KnollStudio* Pixel and Propeller, *Antenna Telescope* bases, *Tone* bases, *k.screens*, and dealer-purchased non BIFMA-certified *Muuto* products.

5 Years: Operational parts, controls, electrical, Lighting (except light ballasts, bulbs and power supply, see below), special or custom product, wood veneer products and plywood, *Currents* handcrank, *KnollStudio* (excluding textiles, leather and outdoor finishes), *LSM, Pixel Lounge, Rockwell Unscripted* wire bases, *KnollExtra* CPU holders and all universal storage drawers, and *Power Collection, k.bench* (except changes in finish, see below) and *k.stand* bases (except changes in finish, see below), *Islands Collection* veneer worksurfaces, operational parts, wide grommet lid, castors, glides and electrical; and dealer-purchased non BIFMA-certified *Muuto* products.

3 Years: *Rockwell Unscripted* upholstery (except textiles and leather), *Office Seating* upholstery, textiles, leathers and finishes. Fabric boards textiles and *Smokador* Collection leathers, *KnollExtra* Pop Up Screens, *k.screen* (except cork and PET), and retailer-purchased *Muuto* products.

2 Years: *Anchor Storage* digital locks, *Quoin* digital locks, all other *KnollExtra* product.

1 Year: Light ballasts, bulbs and power supply, seating upholstered armpads and soft armpads, wood casegoods, upholstered surfaces, *KnollStudio*, textiles, leathers and outdoor product finishes, *Pixel Lounge* fabric, *k. lounge* upholstery and *k. lounge* fabric, *Rockwell Unscripted* fabric and accessories, *k.screen* cork and PET.

This warranty does not apply to:

- Damage caused by a carrier other than the Seller.
- Normal wear and tear or acts or omissions of parties other than Seller (including user modification, improper use or installation of Products).
- COM or other third party materials applied to Products.
- Products not installed by or under the auspices of a Knoll Dealer.
- Dramatic temperature variations or exposure to unusual conditions.
- Changes in surface finishes, including colorfastness due to aging or exposure to light.
- Except as specifically noted above, textiles and upholstery supplied by *KnollTextiles* and Spinneybeck FilzFelt (consult current price lists for applicable warranties).

Natural variations occurring in wood, marble, and leather shall not be considered defects, and the Seller does not guarantee the colorfastness or matching of the colors, grains or textures, or surface hardness of such materials. The Seller also does not guarantee the colorfastness of fiberglass panel surfaces.

THE EXPRESS WARRANTIES CONTAINED HEREIN ARE IN LIEU OF ALL OTHER WARRANTIES, EXPRESS OR IMPLIED, INCLUDING ANY WARRANTIES OF MERCHANTABILITY AND FITNESS FOR PARTICULAR PURPOSE AND ALL OTHER WARRANTIES ARISING FROM COURSE OF DEALING OR USAGE OF TRADE.

The remedies provided above are the Purchaser's sole remedies for any failure of Seller to comply with its obligations regarding the workmanship of its Products. Correction of any nonconformity in the manner and for the period of time provided shall constitute complete fulfillment of all liabilities of Seller, with

# Selling Policy

---

respect to or arising out of the Product furnished hereunder.

**Delay/Force Majeure** Seller shall not be liable for failure to perform or for delay in performance due to fire, flood, strike or other labor difficulty, act of God, act of war or terrorism, act of any governmental authority or of the Purchaser, riot, embargo, fuel or energy shortage, wrecks or delay in transportation, inability to obtain necessary labor, materials or manufacturing facilities from usual sources or failure of suppliers to meet their contractual obligations, or due to any cause beyond its reasonable control. If any such event occurs, Seller may extend delivery dates by a period of time necessary to overcome the effect of such delay, allocate available Product or cancel any purchase order.

**Compliance with Law** PURCHASER IS SOLELY RESPONSIBLE FOR COMPLIANCE WITH ALL APPLICABLE FEDERAL, STATE AND LOCAL LAWS, ORDINANCES, REGULATIONS, RULES AND STANDARDS RELATING TO THE INSTALLATION, MAINTENANCE, USE AND OPERATION OF THE PRODUCTS.

**Patents** Subject to the following provisions, Seller shall, at its own expense, defend or, at its option, settle any claim, suit or proceeding brought against the Purchaser, and/or its vendees, mediate and immediate, so far as based on an allegation that any Product or any part thereof furnished hereunder constitutes a direct or a contributory infringement of any claim of any patent of the United States or Canada. This obligation shall be effective only if Purchaser shall have made all payments then due hereunder and if Seller is notified promptly in writing and given authority, information and assistance for the defense of said claim, suit or proceeding. Seller shall pay all damages and costs awarded in such suit or proceedings so defended.

The foregoing indemnity does not apply to the following:

- Products supplied according to a design other than that of Seller, and which is required by the Purchaser.
- Combination of the Product with another product not furnished hereunder unless Seller is a contributory infringer.
- Any settlements of a suit or proceeding made without Seller's written consent.

**Limitations of Liability** **SELLER, ITS CONTRACTORS, AUTHORIZED DEALERS AND SUBCONTRACTORS OR SUPPLIERS OF ANY TIER SHALL NOT BE LIABLE TO PURCHASER FOR ANY SPECIAL, INDIRECT, INCIDENTAL OR CONSEQUENTIAL DAMAGES ARISING FROM A BREACH OF THIS AGREEMENT.**

Purchaser's remedies set forth herein are exclusive and the liability of Seller with respect to the breach of this agreement or any contract entered into between the parties pursuant hereto shall not exceed the price of the Product or part on which such liability is based.